

POOLEX

SILVERLINE FI

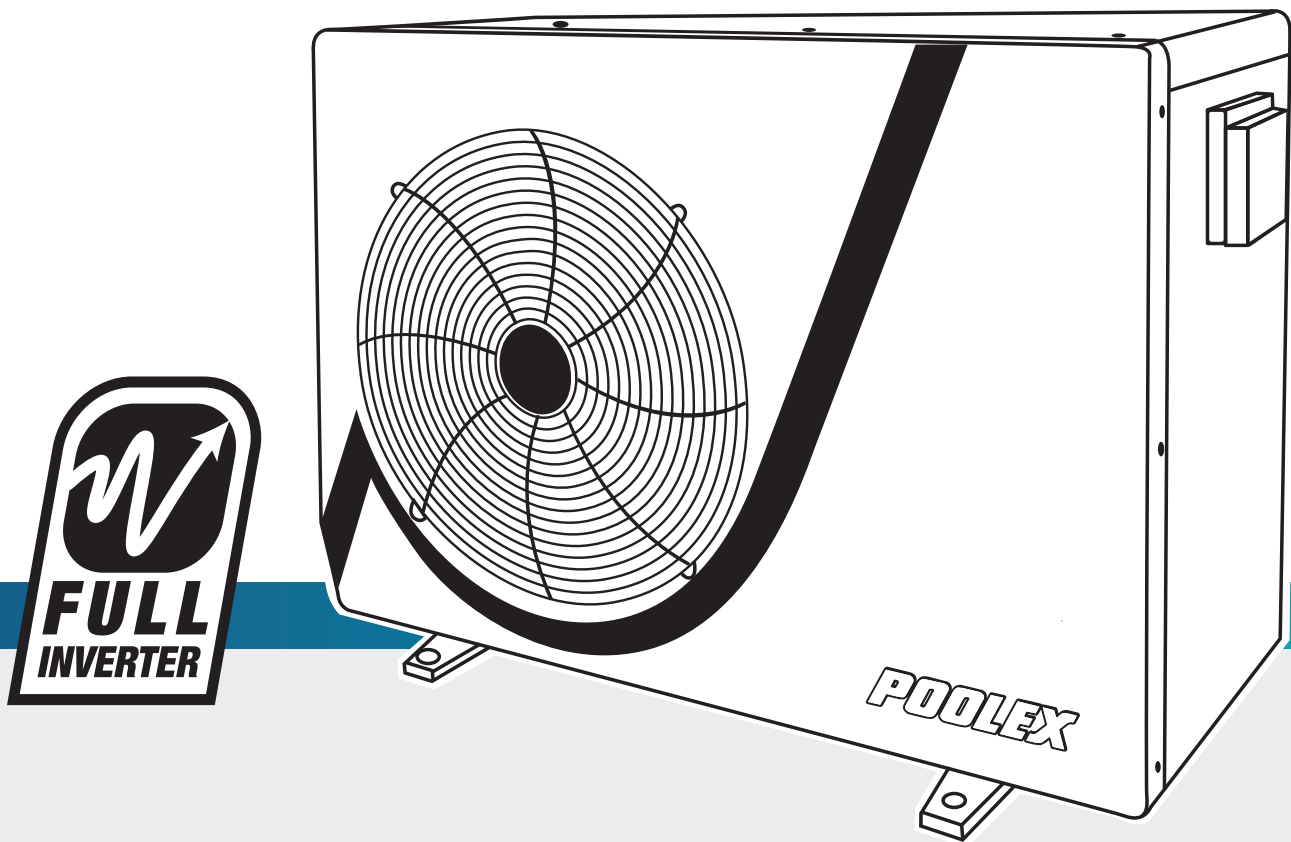

INSTALLATION AND USER MANUAL
of your heat pump

WARNING



This heat pump contains a flammable refrigerant R32.

Any intervention on the refrigerant circuit is prohibited without a valid authorization.

Before working on the refrigerant circuit, the following precautions are necessary for safe work.

1. Work procedure

The work must be carried out according to a controlled procedure, in order to minimize the risk of presence of flammable gases or vapors during the execution of the works.

2. General work area

All persons in the area must be informed of the nature of the work in progress. Avoid working in a confined area. The area around the work area should be divided, secured and special attention should be paid to nearby sources of flame or heat.

3. Verification of the presence of refrigerant

The area should be checked with a suitable refrigerant detector before and during work to ensure that there is no potentially flammable gas. Make sure that the leak detection equipment used is suitable for flammable refrigerants, ie it does not produce sparks, is properly sealed or has internal safety.

4. Presence of fire extinguisher

If hot work is to be performed on the refrigeration equipment or any associated part, appropriate fire extinguishing equipment must be available. Install a dry powder or CO2 fire extinguisher near the work area.

5. No source of flame, heat or spark

It is totally forbidden to use a source of heat, flame or spark in the direct vicinity of one or more parts or pipes containing or having contained a flammable refrigerant. All sources of ignition, including smoking, must be sufficiently far from the place of installation, repair, removal and disposal, during which time a flammable refrigerant may be released into the surrounding area. Before starting work, the environment of the equipment should be checked to ensure that there is no risk of flammability. «No smoking» signs must be posted.

6. Ventilated area

Make sure the area is in the open air or is properly ventilated before working on the system or performing hot work. Some ventilation must be maintained during the duration of the work.

7. Controls of refrigeration equipment

When electrical components are replaced, they must be suitable for the intended purpose and the appropriate specifications. Only the parts of the manufacturer can be used. If in doubt, consult the technical service of the manufacturer.

The following controls should be applied to installations using flammable refrigerants:

- *The size of the load is in accordance with the size of the room in which the rooms containing the refrigerant are installed;*
- *Ventilation and air vents work properly and are not obstructed;*
- *If an indirect refrigeration circuit is used, the secondary circuit must also be checked.*
- *The marking on the equipment remains visible and legible. Illegible marks and signs must be corrected;*
- *Refrigeration pipes or components are installed in a position where they are unlikely to be exposed to a substance that could corrode components containing refrigerant*

8. Verification of electrical appliances

Repair and maintenance of electrical components must include initial safety checks and component inspection procedures. If there is a defect that could compromise safety, no power supply should be connected to the circuit until the problem is resolved.

Initial security checks must include:

- *That the capacitors are discharged: this must be done in a safe way to avoid the possibility of sparks;*
- *No electrical components or wiring are exposed during loading, recovery or purging of the refrigerant gas system;*
- *There is continuity of grounding.*

THANK YOU

Dear Customer,

Thank you for your purchase and for your confidence in our products.

These are the result of many years of research in the field of design and production of heat pumps for swimming pools. Our aim is to provide you with an exceptional high performance quality product.

We have produced this manual with the utmost care so that you get maximum benefit from your Poolex heat pump.

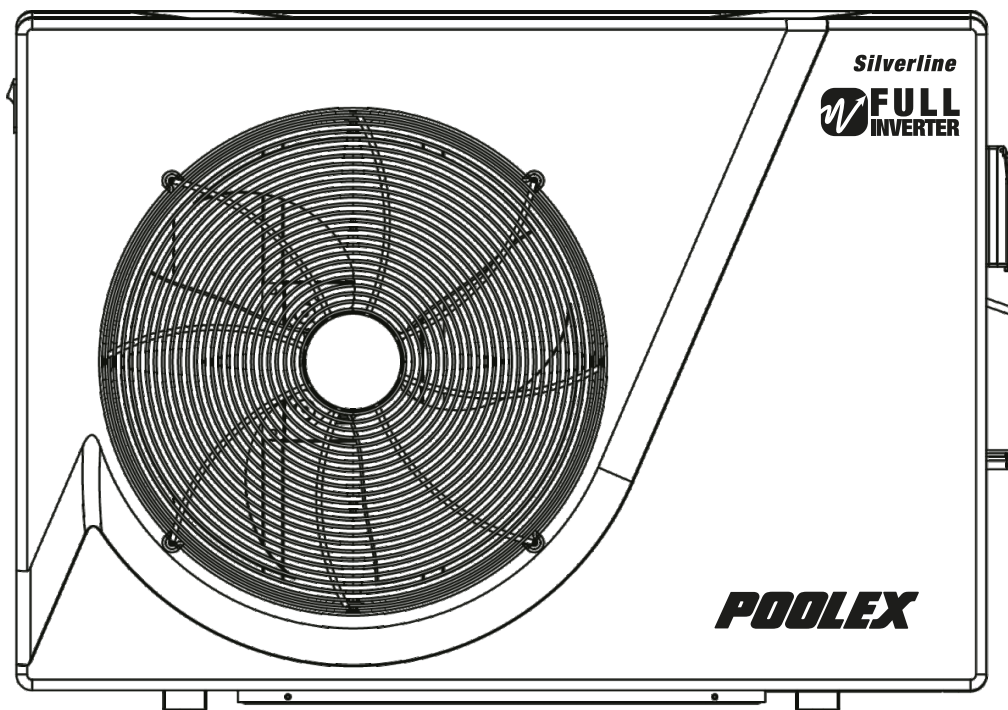



PLEASE READ CAREFULLY



These installation instructions are an integral part of the product.

They must be given to the installer and retained by the user.

If the manual is lost, please consult the website:

www.poolex.fr

The instructions and recommendations contained in this manual should be read carefully and understood since they provide valuable information concerning the heat pump's safe handling and operation. **Keep this manual in an accessible place for easy future reference.**

Installation must be carried out by a qualified professional person in accordance with current regulations and the manufacturer's instructions. An installation error may cause physical injury to persons or animals as well as mechanical damage for which the manufacturer can under no circumstances be held responsible.

After unpacking the heat pump, please check the contents in order to report any damage.

Prior to connecting the heat pump, ensure that the information provided in this manual is compatible with the actual installation conditions and does not exceed the maximum limits authorised for this particular product.

In the event of a defect and/or malfunction of the heat pump, the electricity supply must be disconnected and no attempt made to repair the fault.

Repairs must be undertaken only by an authorised technical service organisation using original replacement parts. Failure to comply with the above-mentioned clauses may have an adverse effect on the heat pump's safe operation.

To guarantee the heat pump's efficiency and satisfactory operation, it is important to ensure its regular maintenance in accordance with the instructions provided.

If the heat pump is sold or transferred, always make sure that all technical documentation is transmitted with the equipment to the new owner.

This heat pump is designed solely for heating a swimming pool. Any other use must be considered as being inappropriate, incorrect or even hazardous.

Any contractual or non-contractual liability of the manufacturer/distributor shall be deemed null and void for damage caused by installation or operational errors, or due to non-compliance with the instructions provided in this manual or with current installation norms applicable to the equipment covered by this document.

CONTENTS

1. General	6
1. 1. General terms of delivery	6
1. 2. Safety instructions	6
1. 3. Water treatment.....	7
2. Description	8
2. 1. Package contents	8
2. 2. General characteristics.....	8
2. 3. Technical specifications	9
2. 4. Unit dimensions	10
2. 5. Exploded view.....	11
3. Installation	12
3. 1. Pre-requirements	12
3. 2. Location.....	12
3. 3. Installation layout	13
3. 4. Connecting the condensation draining kit.....	13
3. 5. Installing the unit on noise-damping supports	13
3. 6. Hydraulic connection.....	14
3. 7. Electrical installation	16
3. 8. Electrical connection	17
4. Use	18
4. 1. Wired remote control.....	18
4. 2. Control box displays	18
4. 3. Operating mode selector	19
4. 4. Temperature settings.....	19
4. 5. Parameter checking and setting	19
4. 6. Setting the clock.....	20
4. 7. Programming Start/Stop	21
4. 8. Key lock and unlock.....	21
4. 9. System parameter query	22
4. 10. Factory parameter query	22
4. 11. WiFi.....	23
5. Operation	28
5. 1. Operation.....	28
5. 2. Servo-control of circulating pump.....	28
5. 3. Using the pressure gauge.....	29
5. 4. Antifreeze protection.....	29
6. Maintenance and servicing	30
6. 1. Maintenance and servicing.....	30
6. 2. Winter storage	30
7. Repairs	31
7. 1. Breakdowns and faults.....	31
7. 2. List of faults.....	32
7. 3. Errors	33
8. Warranty	34
9. Annex	35

1. GENERAL

1. 1. General terms of delivery

All equipment, even if shipped 'free of carriage and packing', is dispatched at the consignee's own risk.

The person responsible for receiving the equipment must carry out a visual inspection to identify any damage to the heat pump during transport (refrigerant system, body panels, electrical control box, frame). He/she must note down on the carrier's delivery note any remarks concerning damage caused during transport and confirm them to the carrier by registered letter within 48 hours.



The equipment must always be stored and transported vertically on a pallet and in its original packaging. If it is stored or transported horizontally, wait at least 24 hours before switching it on.

1. 2. Safety instructions



WARNING: Please read carefully the safety instructions before using the equipment. The following instructions are essential for safety so please strictly comply with them.

During installation and servicing

Only a qualified person may undertake installation, start-up, servicing and repairs, in compliance with current standards.

Before operating or undertaking any work on the equipment (installation, commissioning, usage, servicing), the person responsible must be aware of all the instructions in the heat pump's installation manual as well as the technical specifications.

Under no circumstances install the equipment close to a source of heat, combustible materials or a building's air intake.

If installation is not in a location with restricted access, a heat pump protective grille must be fitted.

To avoid severe burns, do not walk on pipework during installation, repairs or maintenance.

To avoid severe burns, prior to any work on the refrigerant system, turn off the heat pump and wait several minutes before placing temperature and pressure sensors.

Check the refrigerant level when servicing the heat pump.

Check that the high and low pressure switches are correctly connected to the refrigerant system and that they turn off the electrical circuit if tripped during the equipment's annual leakage inspection.

Check that there is no trace of corrosion or oil stains around the refrigerant components.

During use

To avoid serious injuries, never touch the fan when it is operating.

Keep the heat pump out of the reach of children to avoid serious injuries caused by the heat exchanger's blades.

Never start the equipment if there is no water in the pool or if the circulating pump is stopped.

Check the water flow rate every month and clean the filter if necessary.

1. GENERAL

During cleaning

Switch off the equipment's electricity supply.

Close the water inlet and outlet valves.

Do not insert anything into the air or water intakes or outlets.

Do not rinse the equipment with water.

During repairs

Carry out work on the refrigerant system in accordance with current safety regulations.

Brazing should be performed by a qualified welder.

When replacing a defective refrigerant component, use only parts certified by our technical department.

When replacing pipework, only copper pipes conforming to Standard NF EN12735-1 may be used for repairs.

When pressure-testing to detect leaks:

- To avoid the risks of fire or explosion, never use oxygen or dry air.
- Use dehydrated nitrogen or a mixture of nitrogen and refrigerant.
- The low and high side test pressure must not exceed 42 bar.

1. 3. Water treatment

Poolex heat pumps for swimming pools can be used with all types of water treatment systems.

Nevertheless, it is essential that the treatment system (chlorine, pH, bromine and/or salt chlorinator metering pumps) is installed after the heat pump in the hydraulic circuit.

To avoid any deterioration to the heat pump, the water's pH must be maintained between 6.9 and 8.0.

2. DESCRIPTION

2. 1. Package contents

- ✓ Heat pump Poolex Silverline FI
- ✓ 2 hydraulic inlet/outlet connectors (50mm diameter)
- ✓ Extension cable for remote control panel
- ✓ This installation and user manual
- ✓ Condensation draining kit
- ✓ Winter storage cover
- ✓ 4 anti-vibration pads (fastenings not supplied)

2. 2. General characteristics

A Poolex heat pump has the following features:

- ▶ CE certification and complies with the RoHS European directive.
- ▶ High performance with up to 80% energy savings compared to a conventional heating system.
- ▶ Clean, efficient and environmentally friendly R32 refrigerant.
- ▶ Reliable high output leading brand compressor.
- ▶ Wide hydrophilic aluminium evaporator for use at low temperatures.
- ▶ User-friendly intuitive remote control.
- ▶ Heavy duty ABS shell, anti-UV treated and easy to maintain.
- ▶ Designed to be silent.
- ▶ Dual antifreeze system to avoid frost damage:

Revolutionary exchanger with patented antifreeze system.

A smart monitoring system to preserve the pipework and liner without emptying the pool in winter.

2. DESCRIPTION

2. 3. Technical specifications

Test conditions	Poollex Silverline FI					
	70	90	120	150	200	
Air ⁽¹⁾ 26°C Water ⁽²⁾ 26°C	Heating power (kW)	6.8~1.94	9.2~2.23	11.3~2.28	14.5~2.25	19.2~2.59
	Power in Silence mode (kW)	3.31~1.54	4.75~2.23	5.77~2.08	7.31~2.25	10.47~2.59
	Consumption (kW)	1.05~0.15	1.46~0.16	1.86~0.13	2.43~0.14	3.14~0.16
	Consumption in Silence mode (kW)	0.36~0.12	0.47~0.16	0.61~0.13	0.72~0.14	1.06~0.16
	COP (Coeff. of performance)	12.9~6.47	13.9~6.3	16.1~6.07	16.1~5.96	16.2~6.1
Air ⁽¹⁾ 15°C Water ⁽²⁾ 26°C	Heating power (kW)	5.2~1.35	6.4~1.4	8.4~1.6	10.5~1.8	14.1~2.08
	Power in Silence mode (kW)	2.7~1.35	3.54~1.45	4.39~1.6	5.28~1.8	7.17~2.08
	Consumption (kW)	1.11~0.21	1.44~0.22	1.83~0.21	2.29~0.24	3.07~0.26
	Consumption in Silence mode (kW)	0.42~0.21	0.55~0.22	0.67~0.21	0.81~0.24	1.08~0.26
	COP (Coeff. of performance)	6.4~4.6	6.3~4.4	7.6~4.5	7.5~4.5	8.0~4.5
Air ⁽¹⁾ 35°C Water ⁽²⁾ 27°C	Cooling power (kW)	3.24	4.0	5.20	6.52	8.73
	Consumption (kW)	0.81	1.04	1.27	1.59	2.15
	EER	3.88	3.8	4.1	4.1	4.06
Air ⁽¹⁾ 15°C Water ⁽²⁾ 26°C MODE FIX	Heating power (kW)	5.2	6.4	8.4	10.5	14.16
	Consumption (kW)	1.10	1.44	1.83	2.29	3.07
	COP (Coeff. of performance)	4.95	4.4	4.5	4.5	4.6
Maximum power (kW)	1.38	1.83	2.62	2.9	4.2	
Maximum current (A)	7	8.5	11.8	14.5	16	
Electricity supply	220~240V / 50Hz					
Protection	IPX4					
Heating temperature range	15°C~40°C					
Cooling temperature range	8°C~28°C					
Operating temperature range	-7°C~43°C					
Unit dimensions L x W x H (mm)	824*334*643			907*334*643	1104*354*743	
Unit weight (kg)	35	37,5	41	46.5	59	
Sound pressure level at 1 m (dBA) ⁽³⁾	37~50	37~51	38~52	40~54	40~54	
Sound pressure level at 10 m (dBA) ⁽³⁾	19~29	19~30	21~31	23~34	23~34	
Hydraulic connection (mm)	PVC 50mm					
Heat exchanger	PVC tank and twisted Titanium coil					
Min. / Max. water flow rate (m ³ /h)	2~4	3~4	4~6	5~7	7~9	
Compressor	GMCC	GMCC	GMCC	MITSUBISHI	GMCC	
Compressor type	Hermetic Rotary DC Inverter Compressor					
Refrigerant	R32					
Réfrigérant mass (kg)	0.3	0.45	0.6	0.65	1	
Fan motor	DC Fan Motor					
Load loss (mCE)	1.1	1.1	1.1	1.1	1.1	
Max. pool volume (m ³) ⁽⁴⁾	30-45	40-50	45-65	65-80	80-110	
Remote control	Wired backlit LCD control screen					
Mode	Heating / Cooling					

The technical specifications of our heat pumps are provided for information purposes only. We reserve the right to make changes without prior notice.

¹ Ambient air temperature

² Initial water temperature

³ Noise at 1 m, at 4 m and at 10 m in accordance with Directives EN ISO 3741 and EN ISO 354

⁴ Calculated for an in-ground private swimming pool covered with a bubble cover.

2. DESCRIPTION

2. 4. Unit dimensions

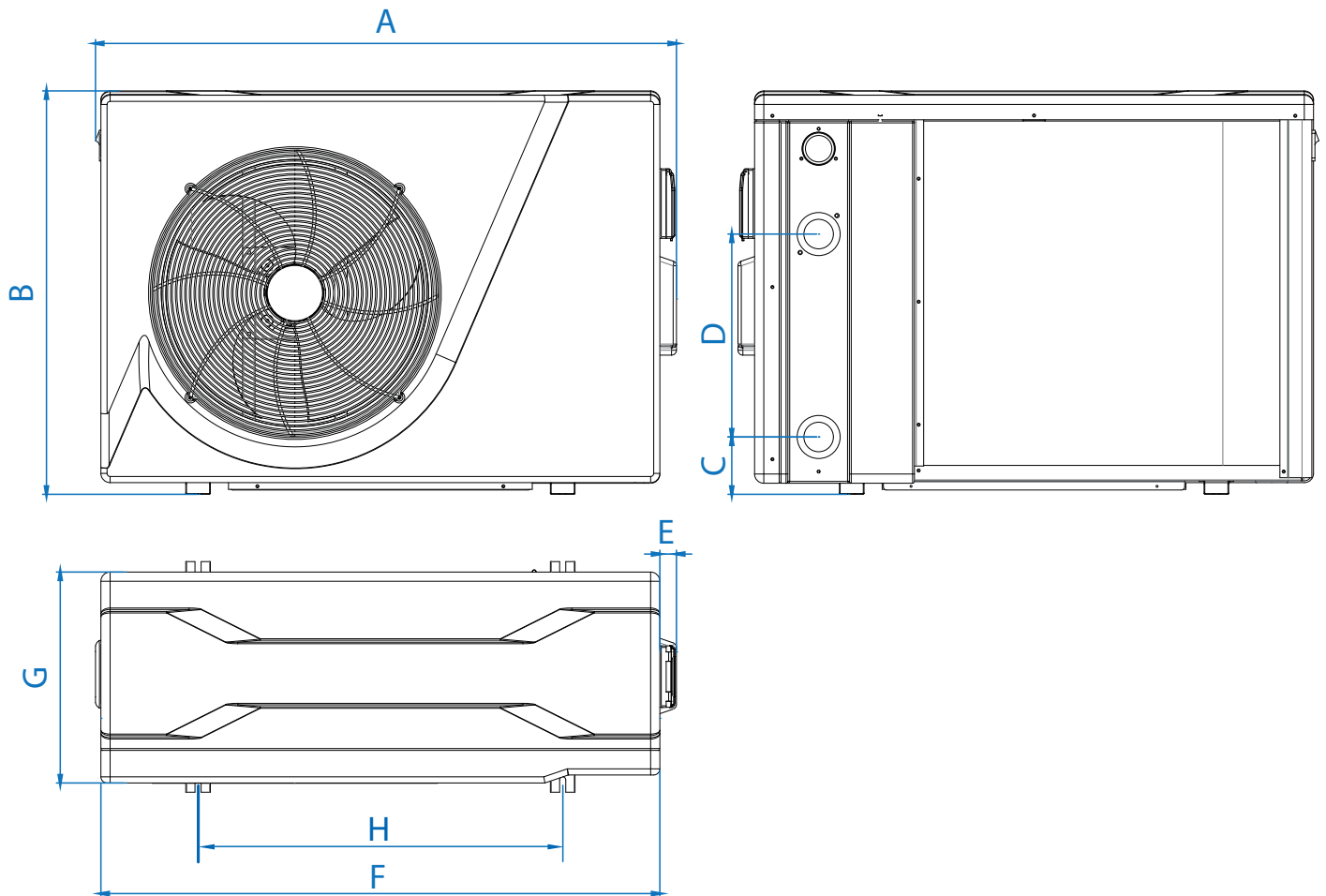

Dimensions en mm

Silverline FI	70 / 90 / 120	150	200
A	865	945	1143
B	656	656	756
C	103	93	71
D	260	330	350
E	27	27	27
F	829	909	1107
G	343	343	363
H	590	593	790

2. DESCRIPTION

2. 5. Exploded view

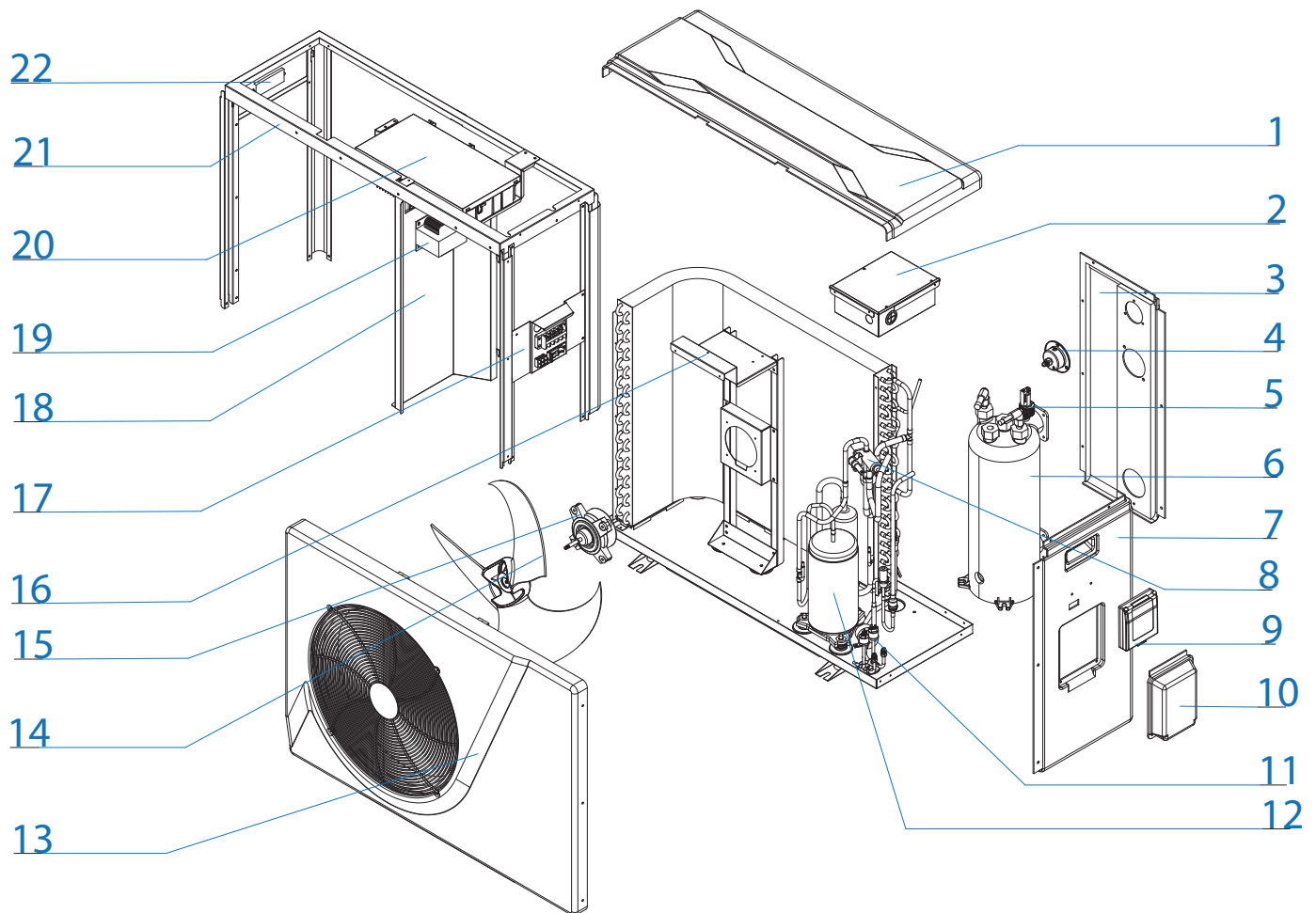

- | | | | |
|-----|------------------------|-----|---------------------------|
| 1. | Top panel | 12. | Compressor |
| 2. | Logic board box | 13. | Front panel |
| 3. | Back panel | 14. | Fan blade |
| 4. | Pressure gauge | 15. | Fan motor |
| 5. | Water Flow Switch | 16. | Fan support |
| 6. | Heat exchanger | 17. | Electrical terminal block |
| 7. | Right side panel | 18. | Middle support |
| 8. | gas pipe | 19. | Electric transformer |
| 9. | Electrical control box | 20. | Electrical control box |
| 10. | Electrical box cover | 21. | Base frame |
| 11. | pressure switch hp/bp | 22. | Right hand grip |

3. INSTALLATION



WARNING: Installation must be carried out by a qualified engineer. This section is provided for information purposes only and must be checked and adapted if necessary according to the actual installation conditions.

3. 1. Pre-requirements

Equipment necessary for the installation of your heat pump:

- ◆ Power supply cable suitable for the unit's power requirements.
- ◆ A By-Pass kit and an assembly of PVC tubing suitable for your installation as well as stripper, PVC adhesive and sandpaper.
- ◆ A set of wall plugs and expansion screws suitable to attach the unit to your support.
- ◆ We recommend that you connect the unit to your installation by means of flexible PVC pipes in order to reduce the transmission of vibrations.
- ◆ Suitable fastening studs may be used to raise the unit.

3. 2. Location

Please comply with the following rules concerning the choice of heat pump location.

1. The unit's future location must be easily accessible for convenient operation and maintenance.
2. It must be installed on the ground, fixed ideally on a level concrete floor. Ensure that the floor is sufficiently stable and can support the weight of the unit.
3. A water drainage device must be provided close to the unit in order to protect the area where it is installed.
4. If necessary, the unit may be raised by using suitable mounting pads designed to support its weight.
5. Check that the unit is properly ventilated, that the air outlet is not facing the windows of neighbouring buildings and that the exhaust air cannot return. In addition, provide sufficient space around the unit for servicing and maintenance operations.
6. The unit must not be installed in an area exposed to oil, flammable gases, corrosive products, sulphurous compounds or close to high frequency equipment.
7. To prevent mud splashes, do not install the unit near a road or track.
8. To avoid causing nuisance to neighbours, make sure the unit is installed so that it is positioned towards the area that is least sensitive to noise.
9. Keep the unit as much as possible out of the reach of children.

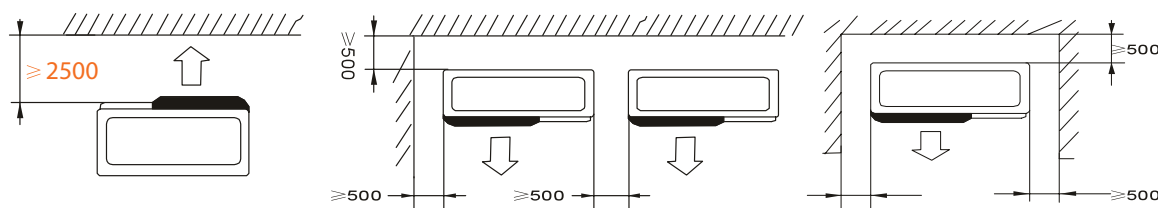

Dimensions in mm

Place nothing less than one metre in front of the heat pump.

Leave 50 cm of empty space around the sides and rear of the heat pump.

Do not leave any obstacle above or in front of the unit!

3. INSTALLATION

3. 3. Installation layout

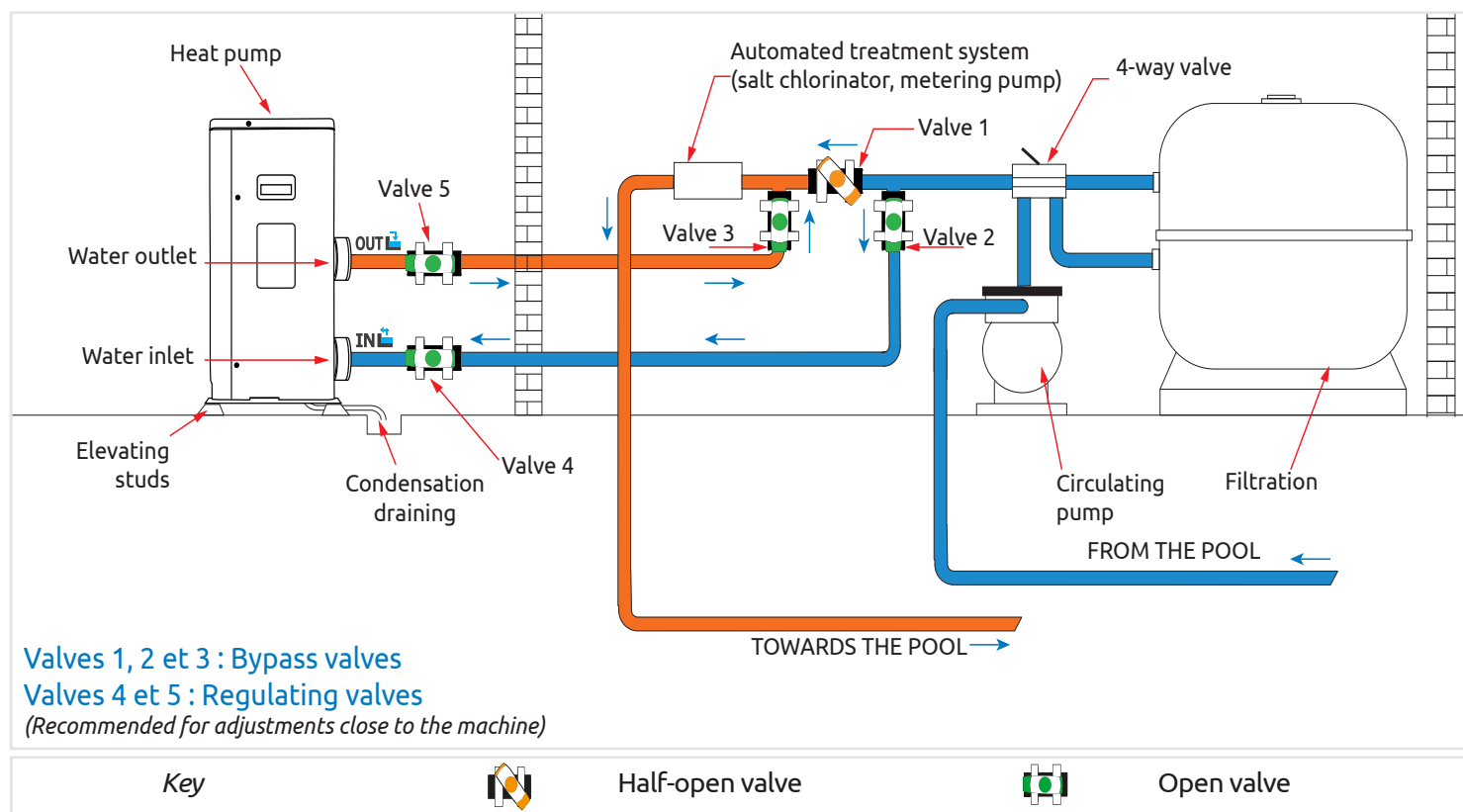

3. 4. Connecting the condensation draining kit

While operating, the heat pump is subject to condensation. This will result in a more or less large run-off of water, depending on the degree of humidity. To channel this flow, we recommend that you install the condensation drainage kit.

How do you install the condensation drainage kit?

Install the heat pump, raising it at least 10 cm with solid water-resistant pads, then connect the drainage pipe to the opening located under the pump.

3. 5. Installing the unit on noise-damping supports

In order to minimise the noise pollution associated with heat pump vibrations, it can be positioned on vibration absorbing pads.

To do this, you simply have to position a pad between each of the unit's feet and its support, and then fix the heat pump to the support with suitable screws.

3. INSTALLATION



WARNING: Installation must be carried out by a qualified engineer. This section is provided for information purposes only and must be checked and adapted if necessary according to the actual installation conditions.

3. 6. Hydraulic connection

By-Pass assembly

The heat pump must be connected to the pool by means of a By-Pass assembly.

A By-Pass is an assembly consisting of 3 valves that regulate the flow circulating in the heat pump.

During maintenance operations, the By-Pass permits the heat pump to be isolated from the system without interrupting your installation.

Making a hydraulic connection with the By-Pass kit

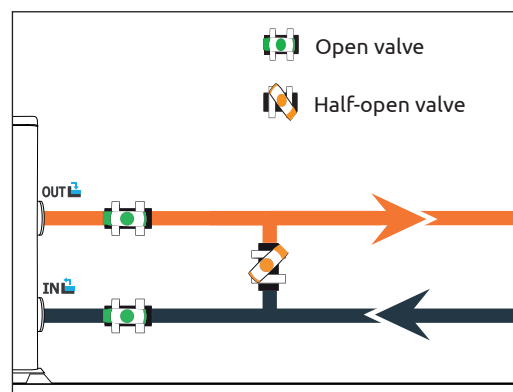

WARNING: Do not run water through the hydraulic circuit for 2 hours after applying the adhesive.

- Step 1:** Take the necessary steps to cut your pipes.
- Step 2:** Make a straight perpendicular cut through the PVC pipes with a saw.

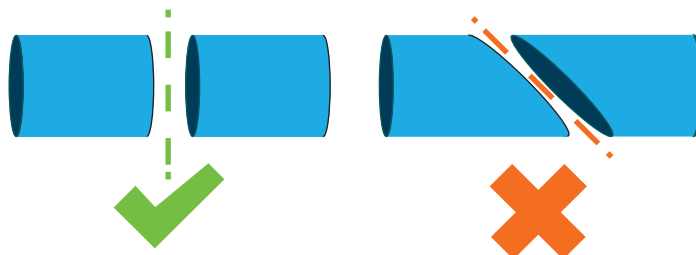

- Step 3:** Assemble your hydraulic circuit without connecting it in order to check that it perfectly fits your installation, then dismantle the pipes to be connected.
- Step 4:** Chamfer the ends of the cut pipes with sandpaper.
- Step 5:** Apply stripper to the ends of the pipes to be connected.
- Step 6:** Apply the adhesive in the same place.
- Step 7:** Assemble the pipes.
- Step 8:** Clean off any adhesive remaining on the PVC.
- Step 9:** Leave to dry for at least 2 hours before putting the hydraulic circuit into water.

3. INSTALLATION

By-Pass assembly for one heat pump

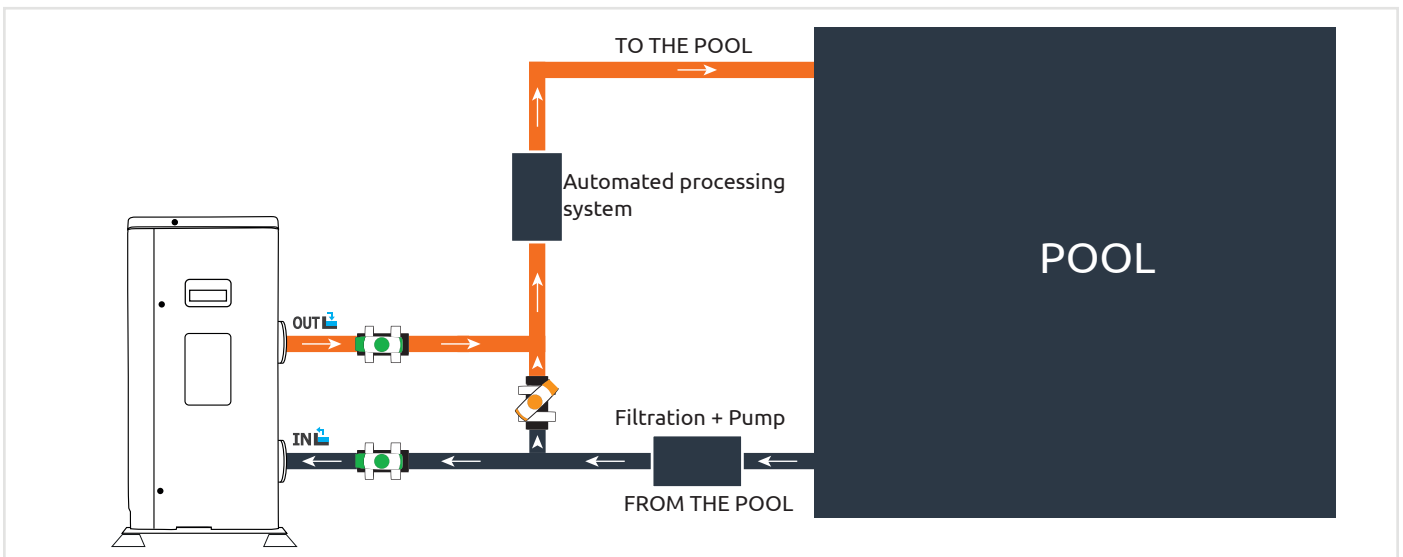

Key



Half-open valve



Open valve

By-Pass assembly for more than one heat pump

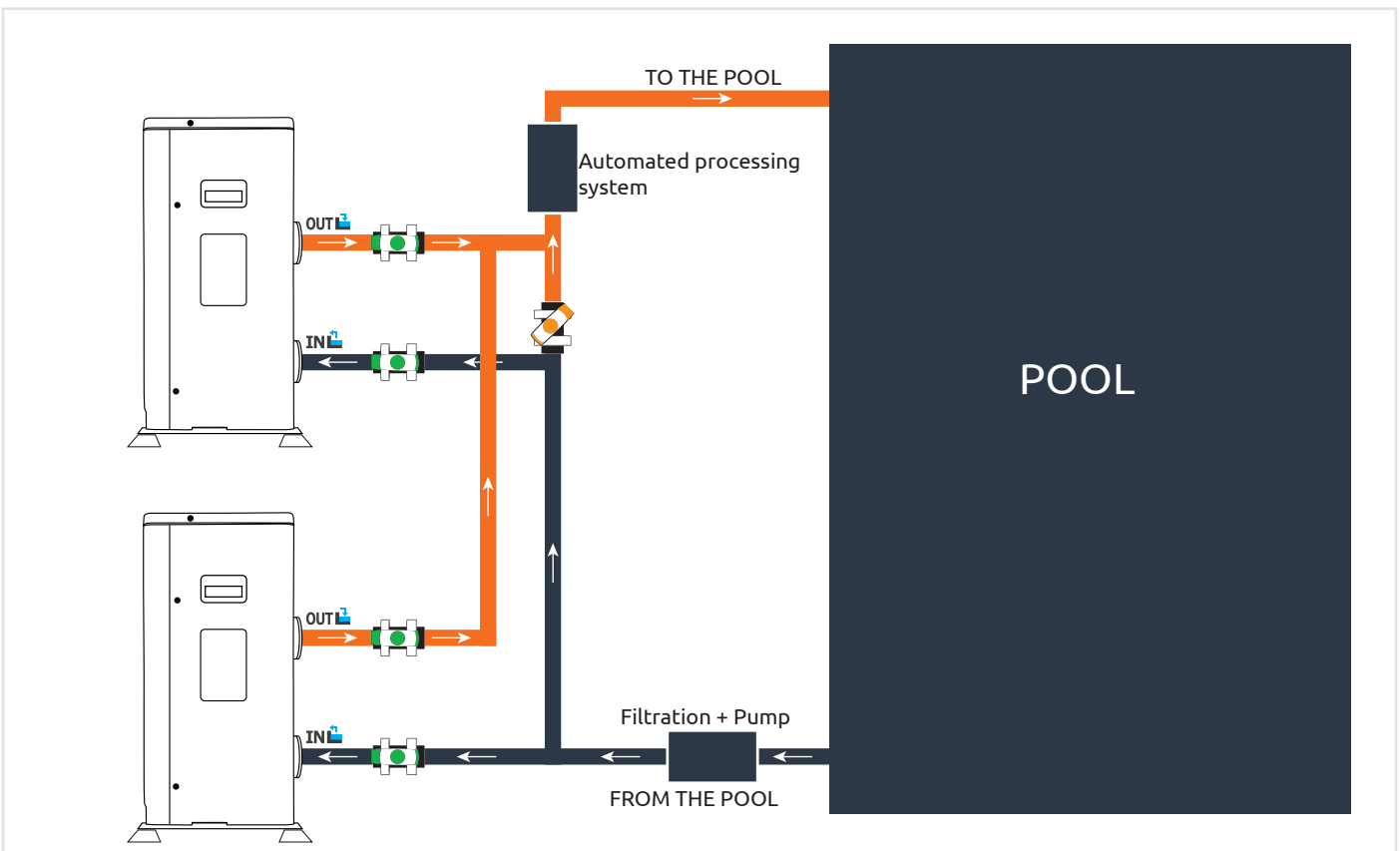

Key



Half-open valve



Open valve

The filter located upstream of the heat pump must be regularly cleared so that the water in the system is clean, thus avoiding the operational problems associated with dirt or clogging in the filter.

3. INSTALLATION



WARNING: Installation must be carried out by a qualified engineer. This section is provided for information purposes only and must be checked and adapted if necessary according to the actual installation conditions.

3. 7. Electrical installation

To function safely and maintain the integrity of your electrical system, the unit must be connected to a general electricity supply in accordance with the following regulations:

Upstream, the general electricity supply must be protected by a 30 mA differential switch.

The heat pump must be connected to a suitable D-curve circuit breaker (see table below) in accordance with current standards and regulations in the country where the system is installed.

The electricity supply cable must be adapted to match the unit's rated power and the length of wiring required by the installation (see table below). The cable must be suitable for outdoor use.

For a three-phase system, it is essential to connect the phases in the correct sequence.

If the phases are inverted, the heat pump's compressor will not work.

In places open to the public, it is mandatory to install an emergency stop button close to the heat pump.

Models	Power supply	Max. current (A)	Diameter of cable	Protection magneto-thermal (curve D)
Silverline FI 70	Single-phase 220-240V/1N~50Hz	8	RO2V 3x2.5 mm ²	16 A
Silverline FI 90		10	RO2V 3x2.5 mm ²	16 A
Silverline FI 120		13	RO2V 3x2.5 mm ²	16 A
Silverline FI 150		15	RO2V 3x4 mm ²	20 A
Silverline FI 200		21	RO2V 3x4 mm ²	25 A

¹ Cable cross-section suitable for max. length 10 metres. For longer than 10 metres, consult an electrician.

3. INSTALLATION

3. 8. Electrical connection



WARNING: The heat pump's power supply **MUST** be disconnected before any operation.

Please comply with the following instructions to electrically connect the heat pump.

- Step 1:** Detach the electrical side panel with a screwdriver to access the electrical terminal block.
- Step 2:** Insert the cable into the heat pump unit by passing it through the opening provided for that purpose.
- Step 3:** Connect the power supply cable to the terminal block in accordance with the diagram below.

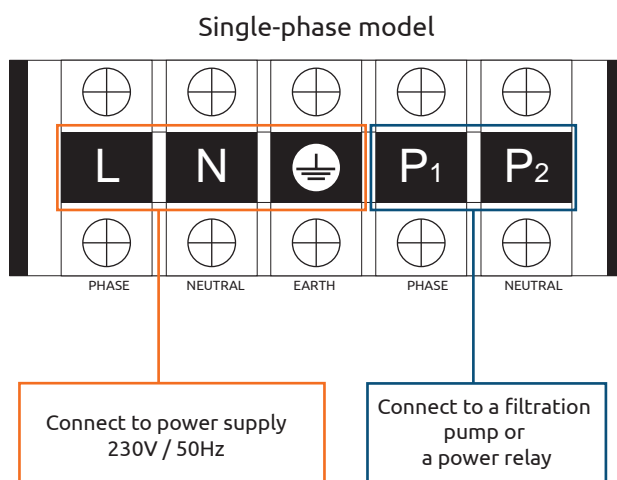

- Step 4:** Carefully close the heat pump panel.

Servo-control of circulating pump

Depending on the type of installation, you can also connect a circulating pump to terminals P1 and P2 so that this operates in tandem with the heat pump.



WARNING: Servo-control of a pump whose power exceeds 5A (1000W) requires the use of a power relay.

4. USE

4. 1. Wired remote control

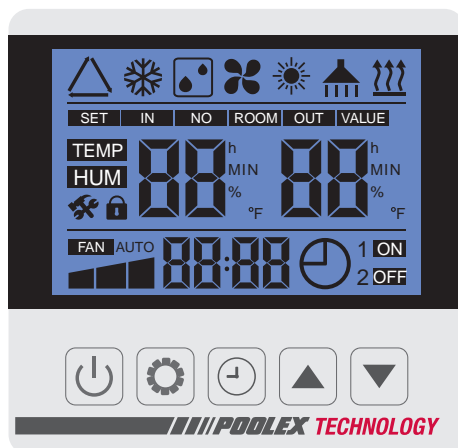

4. 2. Control box displays



Before starting, ensure that the filtration pump is working and that water is circulating through the heat pump.

Prior to setting your required temperature, you must first select an operating mode for your heat pump:

	Cooling mode Full Inverter		Speed compressor
	Heating Mode Full Inverter		Fan speed
	Automatic mode Full Inverter		inlet water temperature
	Heating Mode boost		Parameters menu
	Cooling boost		Temperature unit
	Heating Mode Eco Silence		Clock
	Cooling Eco Silence		Timer function
	Defrost		Keypad lock
	Temperature setting		Timer On/Off
	Setpoint and water inlet temperature		



4. USE

4. 3. Operating mode selector

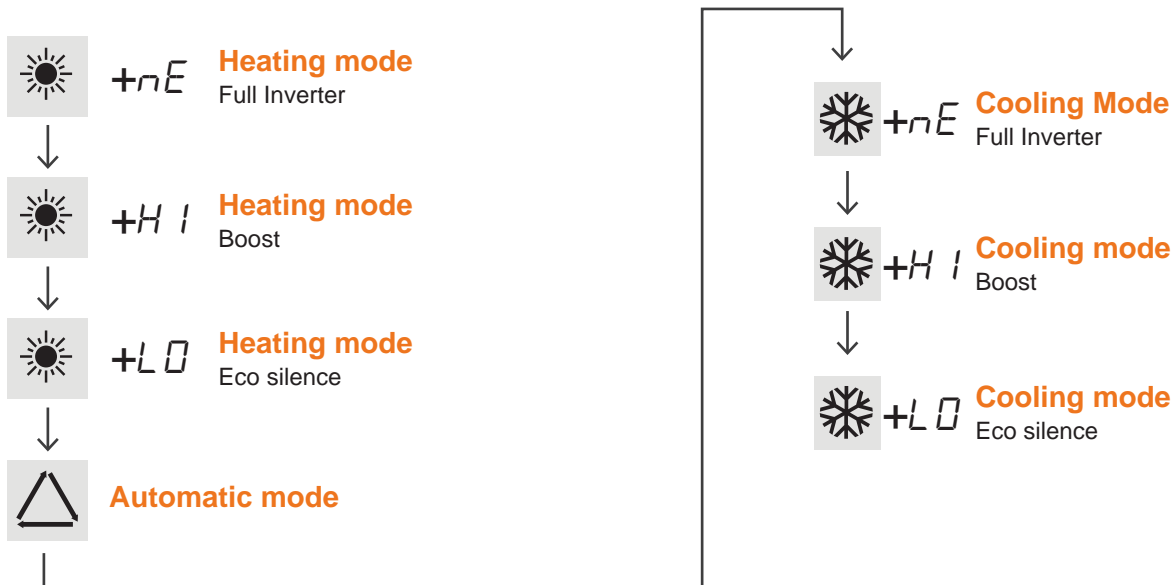
Push on  to change the operating mode. The different modes appear in the following order:



4. 4. Temperature settings

Once the control panel is unlocked, press  and  to set and modify the value, press SET to confirm the value. Press  to confirm the parameters.

4. 5. Parameter checking and setting



Step 1: To enter the verification parameters, Keep pressing  press for 3 seconds, then scroll through the parameters with the buttons  and .

Table of values in annex «9. Annex», page 35.











WARNING:

When the cooling mode switches to heating mode or vice-versa, the heat pump will restart after 10 minutes.

When the incoming water temperature is less than or equal to the required temperature (setpoint temperature - 1°C), the heat pump will switch to heating mode. The compressor will stop when the temperature of the incoming water is greater than or equal to the required temperature (setpoint temperature + 1°C).

4. USE

4. 6. Setting the clock

- Step 1:** Press 5s  to enter current time setting.
- Step 2:** Press , the hours are blinking, push  and  to adjust the hours.
- Step 3:** Press , the minutes are blinking, push  and  to adjust the minutes.
- Step 4:** Press  to validate and return to the main screen.

Step 1

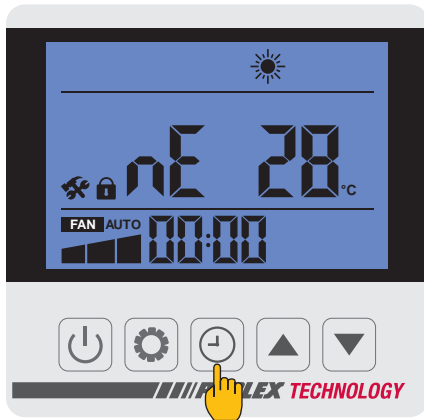

Step 2

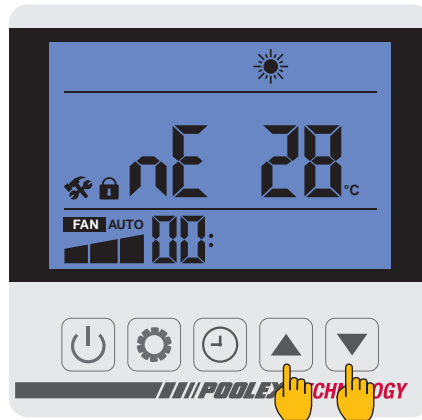

Step 3

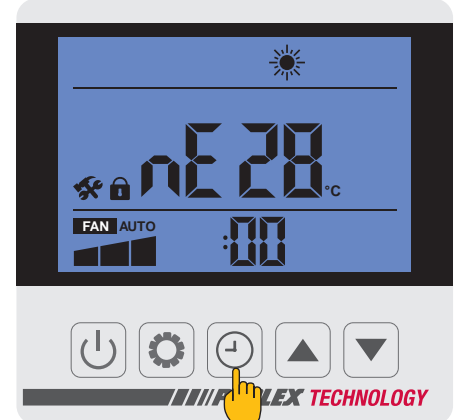

Step 3



Step 4



Useful information













WARNING: When the cooling mode switches to heating mode or vice-versa, the heat pump will restart after 10 minutes.

When the incoming water temperature is higher or equal to the required temperature (setpoint temperature + 1°C), the heat pump will switch to cooling mode. The compressor will stop when the temperature of the incoming water is less than or equal to the required temperature (setpoint temperature - 1°C).

4. USE

4. 7. Programming Start/Stop

This function is for programming the Start/Stop timing. You can programme up to 2 different Start/Stop timings. Setting is as follows:

- Step 1:** Push  to enter into timer functions.
- Step 2:** Timer 1 blinking, press  to enter timer ON 1 hour setting, press  and  to modify the value of starting hours.
- Step 3:** Press  key again, minute are blinking, then press  and  to modify the value of starting minutes.
- Step 4:** Press  again to modify timer OFF, same way as upon.
- Step 5:** Press  again to confirm Timer ON / OFF.
- Step 6:** Press  and  to set timer ON OFF 2 setting.



4. 8. Key lock and unlock

To unlock the control panel, press  for 5 seconds

If no action has been taken on the control unit for 60 seconds, the control panel will lock.

4. USE

4. 9. System parameter query

 **WARNING:** This operation is used to assist servicing and future repairs. The default settings should only be modified by an experienced professional person.

 **WARNING:** Any change to the reserved settings will automatically void the warranty.

The status values can be checked via the remote control by following these steps.

Step 1: Keep pressing  3 s until you enter the settings.

Step 2: Press  and  to check the status values.

Step 3: Press  to return to the main screen.

Step 1

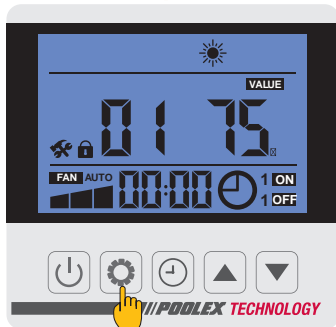

Step 2

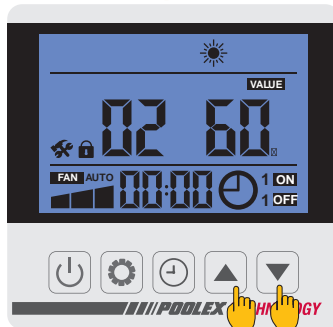

Step 3

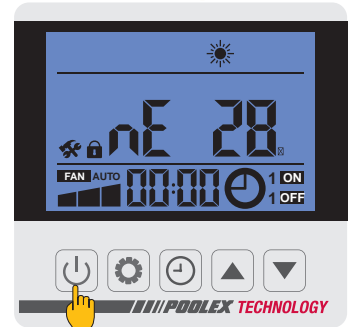



4. 10. Factory parameter query

 **WARNING:** This operation is used to assist servicing and future repairs. The default settings should only be modified by an experienced professional person.

 **WARNING:** Any change to the reserved settings will automatically void the warranty.

The status values can be checked via the remote control by following these steps.

Step 1: Keep pressing  +  3 s until you enter the settings, then enter the password 1688.

Step 2: Press  and  to check the status values.

Step 3: Press  to return to the main screen.

Step 1



Step 2

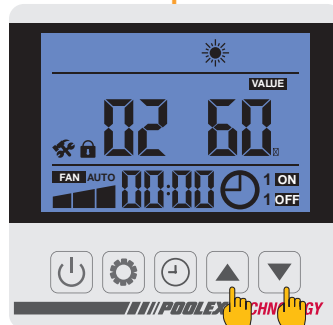

Step 3

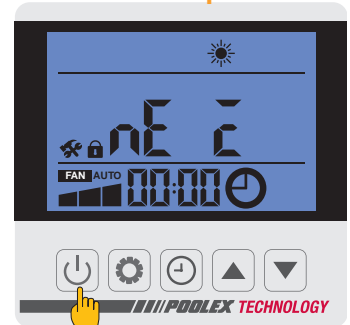

4. USE

4. 11. WiFi

4.11.1. Downloading & Installing the «Smart Life» app

About the Smart Life app:

You'll need to create a 'Smart Life' account to control your heat pump remotely.

The 'Smart Life' app lets you control your home appliances from anywhere. You can add and control multiple devices at once.

- Also compatible with Amazon Echo and Google Home (depending on the country).
- You can share your devices with other Smart Life accounts.
- Receive real-time operational alerts.
- Create scenarios with several devices, depending on the app's weather data (geolocation required).

For more information, go to the 'Help' section of the 'Smart Life' app.

The 'Smart Life' app and services are provided by Hangzhou Tuya Technology. Poolstar, owner and distributor of the Poolex brand, cannot be held responsible for the operation of the 'Smart Life' app. Poolstar has no visibility on your 'Smart Life' account.

iOS:

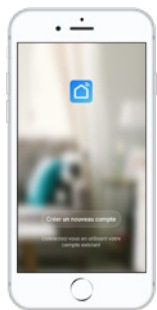

Search for «Smart Life» in the App Store to download the app:



Check the compatibility of your phone and the version of your OS before installing the application.

Android:

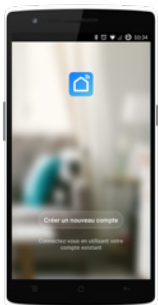

Search for «Smart Life» on Google Play to download the app:



Check the compatibility of your phone and the version of your OS before installing the application.

4. USE

4.11.2. Setting up the app



WARNING : Before you begin, make sure you have downloaded the «Smart Life» app, connected to your local WiFi network, and that your heat pump is electrically powered and running.

You'll need to create a «Smart Life» account to control your heat pump remotely. If you already have a Smart Life account, please log in and go directly to step 3.

- Step 1:** Click on «Create new account» and choose to register by «Email» or «Phone,» where a verification code will be sent to you.
Enter your email address or phone number and click «Send verification code».

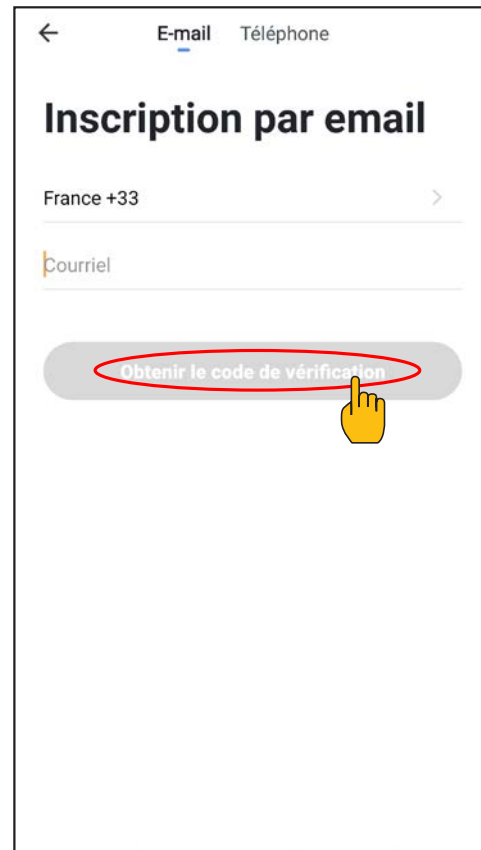
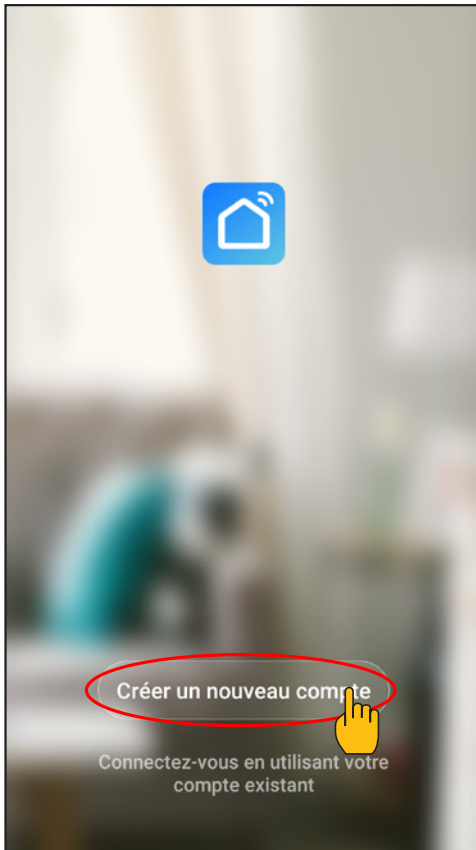

- Step 2:** Enter the verification code received by email or phone to validate your account.

Congratulations! You are now part of the «Smart Life» community.

4. USE

Step 3: (Recommended) Add an object by clicking «...» and then «Add Object.» Enter its name («Pool» for example), then click «Done.»

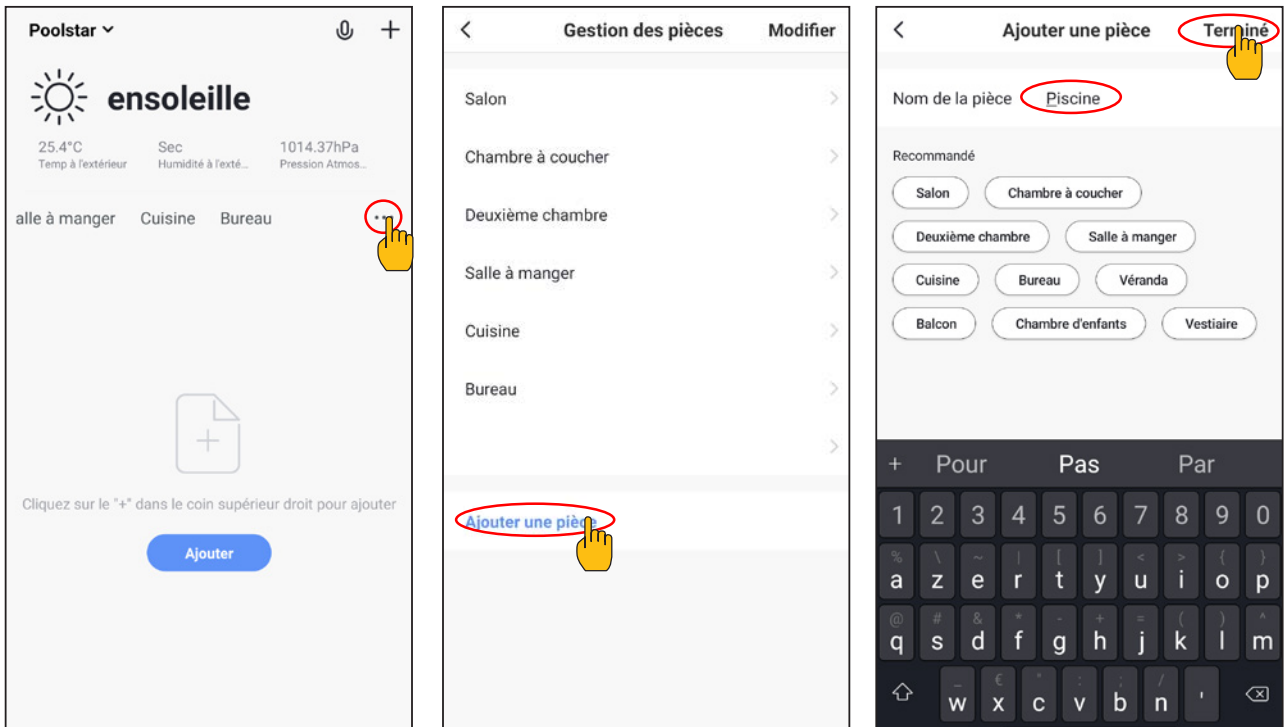

Step 4: Now add a device to your «Pool»
Click «Add» or «+» and then «Large appliances...» followed by «Water heater.»
At this point, leave your smartphone on the «Add» screen and go to the pairing step for your control box.

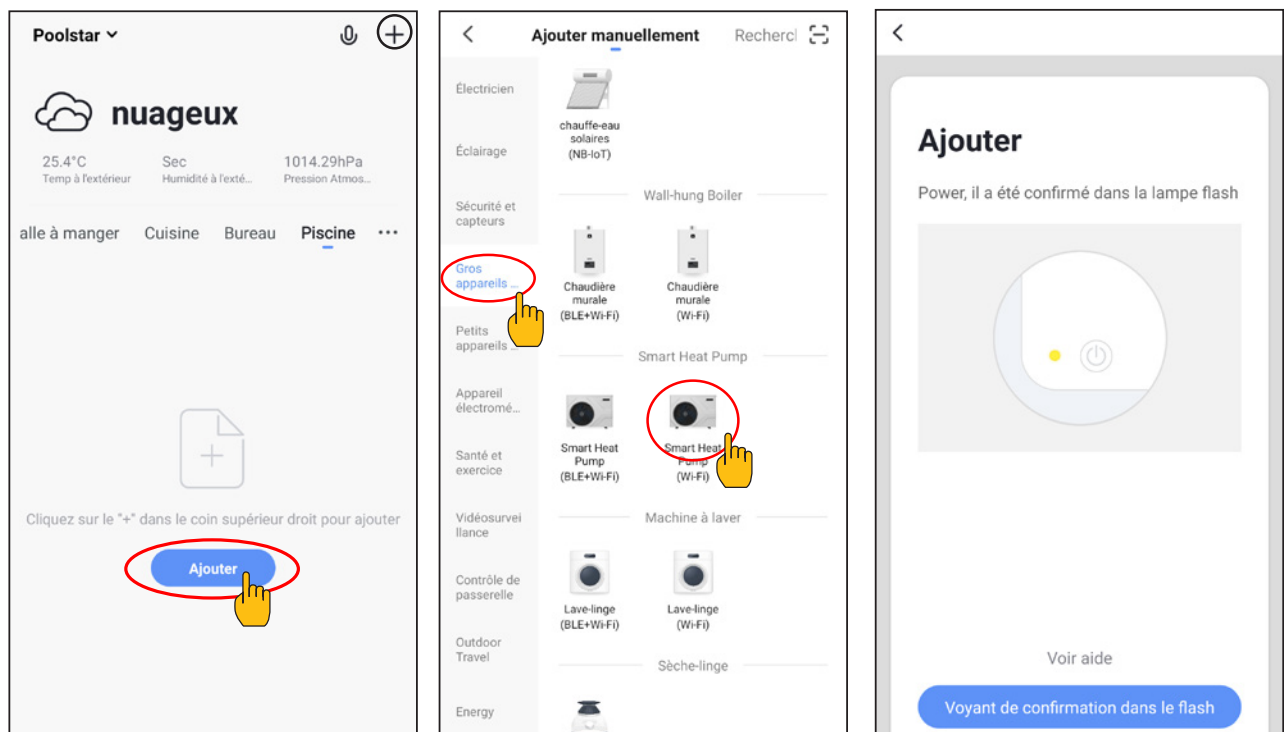

4. USE

4.11.3 Pairing the heat pump

Step 1: Now start the pairing.
Choose your home WiFi network, enter the WiFi password and press «Confirm».

Step 2: Activate the pairing mode on your heat pump according to the following procedure:
The procedure depends on the model of your control box:

EZ Mode (default):

Push + (or) simultaneously for 5s, flashes quickly, the control unit is ready to be paired.

AP mode:

Push + (or) simultaneously for 5s, flashes quickly, the control unit is ready to be paired.



CAUTION: The «Smart Life» application only supports 2.4GHz WiFi networks. If your WiFi network uses the 5GHz frequency, go to the interface of your home WiFi network to create a second 2.4GHz WiFi network (available for most Internet boxes, routers and WiFi access points).

Note: The flashing stops when the box is connected to WiFi

The pairing is successful, you can rename your Pooler heat pump then press «Done».

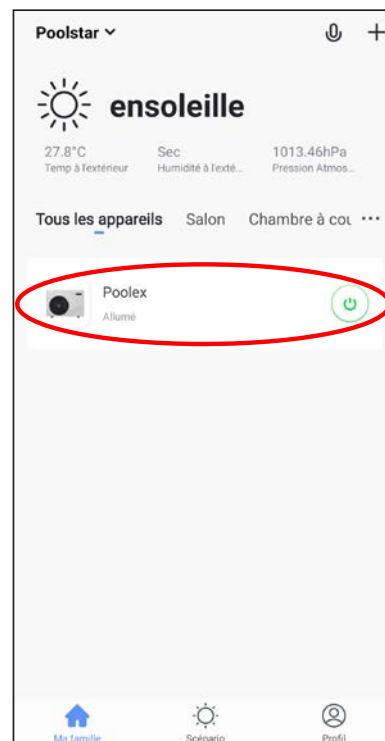
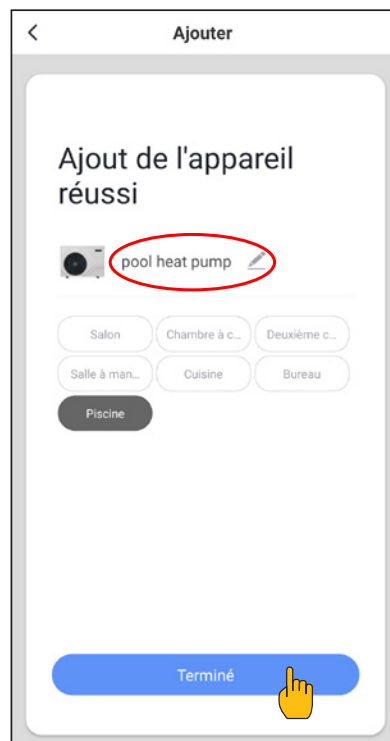

Congratulations, your heat pump can now be controlled from your smartphone.

4. USE

4.11.4. Controlling

Interface

- 1 Current pool temperature
- 2 Temperature setpoint
- 3 Current operating mode
- 4 Switch the heat pump On/Off
- 5 Change the temperature
- 6 Change the operating mode
- 7 Set the operating range



Configure the operating ranges for the heat pump

Step 1: Create a schedule, choose the time, day(s) of the week(s), and the action (turn on or off) and save.

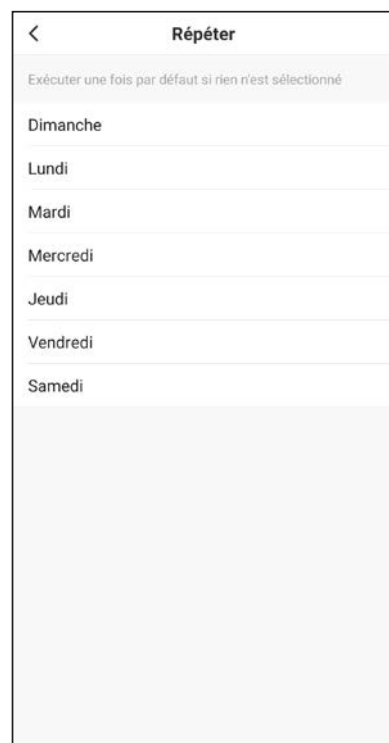
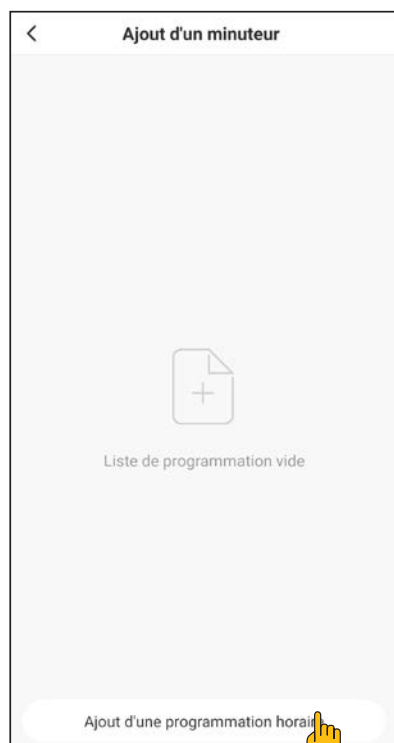

Step 2: To delete a time slot, press on it and hold.

5. OPERATION

5. 1. Operation

Conditions of use

For the heat pump to operate normally, the ambient air temperature must be between -7°C and 43°C.

Recommendation prior to start-up

Before activating the heat pump, please:

- ✓ Check that the unit is firmly secured and stable.
- ✓ Check that the gauge indicates a pressure greater than 80 PSI.
- ✓ Check that the electrical wiring is properly connected to the terminals.
- ✓ Check the earthing.
- ✓ Check that the hydraulic connections are tight and that there is no leakage of water.
- ✓ Check that the water is circulating correctly in the heat pump and that the flow rate is adequate.
- ✓ Remove any unnecessary object or tool from around the unit.

Operation

1. Activate the unit's power supply protection (differential switch and circuit-breaker).
2. Activate the circulating pump if it is not servo-controlled.
3. Check the By-Pass opening and the control valves.
4. Activate the heat pump by pressing once on .
5. Adjust the remote control clock.
6. Select the required temperature by using one of the remote control's mode.
7. The heat pump's compressor will start up after a few moments.

All you have to do now is wait until the required temperature is reached.



WARNING: Under normal conditions, a suitable heat pump can heat the water in a swimming pool by 1°C to 2°C per day. It is therefore quite normal to not feel any temperature difference in the system when the heat pump is working. A heated pool must be covered to avoid any loss of heat.

5. 2. Servo-control of circulating pump

If you have connected a circulating pump to terminals P1 and P2, it is automatically electrically powered when the heat pump operates.

5. OPERATION

5. 3. Using the pressure gauge

The gauge is for monitoring the pressure of the refrigerant contained in the heat pump.

The values it indicates can vary considerably, depending on the climate, temperature and atmospheric pressure.

When the heat pump is in operation

The gauge's needle indicates the refrigerant pressure.

Mean operating range between 250 and 400 PSI, depending on the ambient temperature and atmospheric pressure.

When the heat pump is shut down

The needle indicates the same value as the ambient temperature (within a few degrees) and the corresponding atmospheric pressure (between 150 and 350 PSI maximum).

If left unused for a long period of time

Check the pressure gauge before starting up the heat pump. It must indicate at least 80 PSI.

If the pressure goes down too much, the heat pump will display an error message and automatically go into 'safe' mode.

This means that there has been a leakage of refrigerant and that you must call a qualified technician to replace it.

5. 4. Antifreeze protection



WARNING: For the antifreeze system to work, the heat pump must be powered and the circulating pump activated. If the circulating pump is servo-controlled by the heat pump, it will be automatically activated.

When the heat pump is on standby, the system monitors the ambient temperature and the water temperature in order to activate the antifreeze programme if required.

The antifreeze programme is automatically activated when the ambient temperature or the temperature of the water is less than 2°C and when the heat pump has been shut down for more than 120 minutes.

When the antifreeze programme is running, the heat pump activates its compressor and the circulating pump so as to reheat the water until the water temperature exceeds 2°C.

The heat pump automatically leaves the antifreeze mode when the ambient temperature is greater than or equal to 2°C or when the heat pump is activated by the user.

6. MAINTENANCE AND SERVICING

6. 1. Maintenance and servicing



WARNING: Before undertaking maintenance work on the unit, ensure that you have disconnected the electrical power supply.

Cleaning

The heat pump's casing must be cleaned with a damp cloth. The use of detergents or other household products could damage the surface of the casing and affect its properties.

The evaporator at the rear of the heat pump must be carefully cleaned with a vacuum cleaner and soft brush attachment.

Annual maintenance

The following operations must be undertaken by a qualified person at least once a year.

- ✓ Carry out safety checks.
- ✓ Check the integrity of the electrical wiring.
- ✓ Check the earthing connections.
- ✓ Monitor the state of the pressure gauge and the presence of refrigerant.

6. 2. Winter storage

In the winter months when the ambient temperature is lower than 3°C, a shut-down heat pump must be winterised to avoid any frost damage.

Winterising in 4 steps

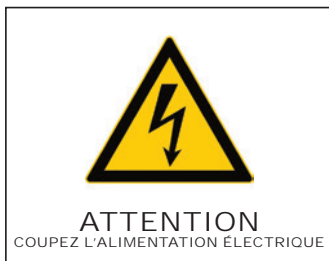

Step 1

Disconnect the heat pump from the power supply.

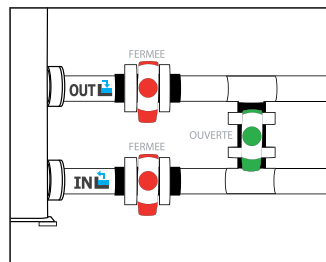

Step 2

Open the By-Pass valve. Close the inlet and outlet valves.

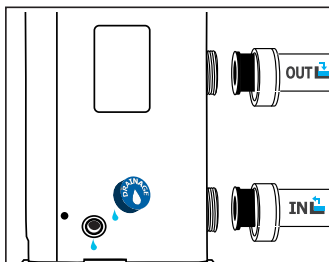

Step 3

Unscrew the drain plug and water pipes in order to drain any water from the heat pump.

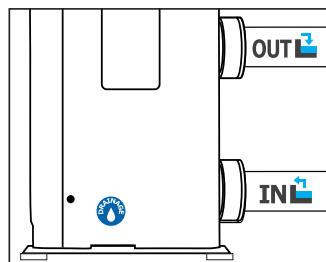

Step 4

Screw back the drain plug and pipes or block them with rags so as to prevent any foreign bodies from getting into the circuit. Finally, protect the pump with its winter storage cover.



If a circulating pump is servo-controlled by the heat pump, drain this also.

7. REPAIRS



WARNING: Under normal conditions, a suitable heat pump can heat the water in a swimming pool by 1°C to 2°C per day. It is therefore quite normal to not feel any temperature difference in the system when the heat pump is working. A heated pool must be covered to avoid any loss of heat.

7. 1. Breakdowns and faults

In the event of a problem, the heat pump's screen displays a fault symbol *Er* instead of temperature indications. Please consult the table opposite to find the possible causes of a fault and the actions to be taken.

Fault code examples:

Fault code 03

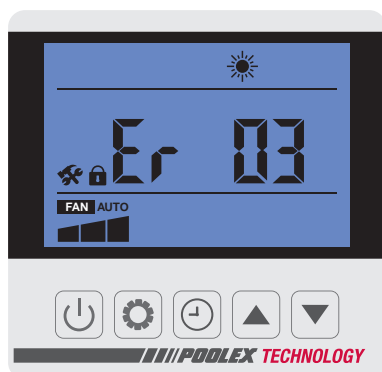

Fault code 04

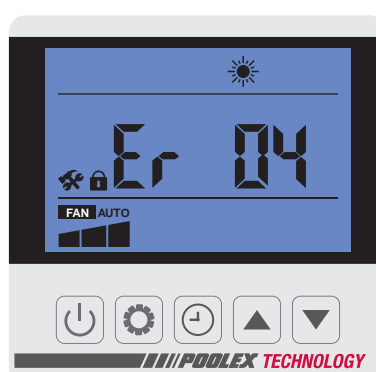

Fault code 21

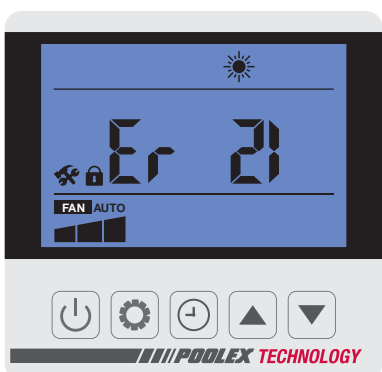

Fault code 32

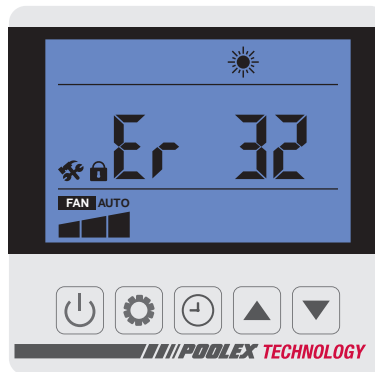

7. REPAIRS

7. 2. List of faults

Code	Faults	Possible cause	Actions
03	Flow sensor malfunction	Insufficient water in heat exchanger	Check your water circuit operation and the opening of the By-Pass valves
		Sensor disconnected or defective	Reconnect or replace sensor
04	Antifreeze protection	Protection activated when the ambient temperature is too low and the unit is on standby	No intervention is necessary
05	High pressure protection	Insufficient water flow	Check water pump operation and openings of By-Pass inlet/outlet valves
		Excess refrigerant gas	Readjust the refrigerant volume
		Defective 4-way valve	Replace the 4-way valve
		High pressure switch disconnected or defective	Reconnect or replace high pressure switch
06	Low pressure protection	Insufficient refrigerant gas	Readjust the refrigerant volume
		Defective 4-way valve	Replace valve
		Low pressure switch disconnected or defective	Reconnect or replace low pressure switch
09	Connection problem between PCB and wired remote control	Bad connection	Check wiring connections between remote control and PCB
		Defective wired remote control	Replace remote control
		Defective PCB	Replace PCB
10	Connection problem between PCB and inverter module	Bad connection	Check wiring connections between PCB and inverter module
		Defective inverter module	Replace inverter module
		Defective PCB	Replace PCB
11	Temperature difference too big between inlet and outlet water temperature	Insufficient water flow	The error code will disappear after three minutes and the unit will start working again. If this error code occurs three times, switch off the unit to clear the error.
12	Vented air temperature too high	Insufficient refrigerant gas	Readjust the refrigerant volume
13	Ambient temperature protection	The ambient temperature is beyond the unit working temperature range	Unit stop working
		The sensor is abnormal or too close to the heat exchanger surface	Change the position for ambient temperature sensor to right position
14	Water temperature at outlet too low for cooling mode	Insufficient water flow	Check water pump operation and openings of By-Pass inlet/outlet valves
15	Water intake temperature sensor malfunction	Sensor disconnected or defective	Reconnect or replace sensor
16	Outside coil temperature error	Sensor disconnected or defective	Reconnect or replace sensor
18	Vented temperature error	Sensor disconnected or defective	Reconnect or replace sensor
20	Inverter module protection (see next paragraph for more details)	Defective inverter module	Power off the heat pump and restart Replace inverter module
		Compressor is defective	Replace the compressor
21	Ambient temperature error	Sensor disconnected or defective	Reconnect or replace sensor
23	Water temperature at outlet too low for cooling mode	Insufficient water flow	Check water pump operation and openings of By-Pass inlet/outlet valves
27	Water outlet error	Sensor disconnected or defective	Reconnect or replace sensor
29	Backed temperature error	Sensor disconnected or defective	Reconnect or replace sensor
32	Outlet temperature too high for heating mode protection	Insufficient water flow	Check that the water is circulating properly in the heat pump, and that the Bypass inlet/outlet valves are open.

7. REPAIRS

Code	Faults	Possible cause	Actions
33	Outdoor coil temperature too high protection for cooling more	Ambient temperature or water temperature too high	Make sure the unit is working in available temp. range for ambient and water temp.
		Poor heat exchanger for evaporator	Check if the evaporator is blocked and clean
		Gas pipe blocked for cooling system	Check if the gas pipe is blocked
		Defective temperature sensor	Replace temperature sensor
		Defective fan motor	Check and replace fan motor
34	Fan motor error	Defective fan motor	Replace fan motor
		Defective PCB	Replace PCB
		Defective fan blade or blocked	Clean the fan blade or replace a new one
35	Compressor current protection	The speed of compressor is too high	Compressor will be lower the speed auto
		Water temperature is too high	Check water pump operation and openings of By-Pass inlet/outlet valves
		Ambient temperature is too high, air volume is too little	Check the fan is working properly and the air inlet is unobstructed
42	Inside coil temperature error	Sensor disconnected or defective	Reconnect or replace sensor
99	Software error	Defective PCB	Replace PCB
		Wrong software version	Update the software version

7. 3. Errors

Error 20 is supplemented by another informative number, given in the following table:

Code	Faults	Possible cause	Actions
1	IPM excessive current	IPM module failure	Replace the inverter module
2	Compressor failure	Compressor failure	Replace the compressor
1b	DC bus voltage too low	Input voltage too low/PFC module failure	Check input voltage/replace module
2b0	AC input voltage too high	Input three-phase unbalance	Check input the 3-phase voltage
2b4	AC input voltage too low	Input voltage too low	Check input voltage
2b8	IPM temp too high	Fan motor failure/Air duct blockage	Check fan motor/air duct

8. WARRANTY

8. 1. General warranty conditions

The Poolstar Company guarantees the original owner against defective materials and faults in the manufacture of the Poolx Jetline Premium Inverter heat pump for a period of **two (2) years**.

The compressor is guaranteed for a period of **five (5) years**.

The titanium tube heat exchanger is guaranteed for a period of **fifteen (15) years** against chemical corrosion, except for frost damage.

The condenser's other components are guaranteed for **two (2) years**.

The warranty becomes effective on the date of the first invoice.

The warranty does not apply in the following cases:

- Malfunction or damage arising from an installation, usage or repair that is not in compliance with the safety instructions.
- Malfunction or damage arising from a chemical agent that is unsuitable for the pool.
- Malfunction or damage arising from conditions that are unsuitable for the equipment's purposes of use.
- Damage arising from negligence, accident or force majeure.
- Malfunction or damage arising from the use of unauthorised accessories.

Repairs undertaken during the warranty period must be approved prior to being carried out by an authorised technician. The warranty shall be null and void if the repair to the equipment is carried out by a person who is not authorised by the Poolstar company.

The guaranteed parts shall be replaced or repaired at Poolstar's discretion. Defective parts must be returned to our workshops to be covered during the warranty period. The warranty does not cover labour costs or unauthorised replacements. The return of the defective part is not covered by the warranty.

Dear customer,

A question? A problem? Or simply register your warranty, find us on our website:

<https://assistance.poolstar.fr/>

Thank you for your trust and support. Happy bathing!



Your personal information is processed in accordance with the French Data Protection Act of 06 January 1978 and will not be shared with 3rd parties.

9. ANNEX

9. 1. Parameter checking

To enter the verification parameters, keep pressing  press for 3 seconds.

Code	Description	Note
<i>T1</i>	Air discharge temp.	
<i>T2</i>	Air suction temp.	
<i>T3</i>	Inlet water temp.	
<i>T4</i>	Outlet water temp.	
<i>T5</i>	Outdoor coil temp.	
<i>Tb</i>	Outdoor ambient temp.	
<i>T7</i>	IPM temp.	
<i>T8</i>	Indoor coil temp.	
<i>T9</i>	Reserve	
<i>T10</i>	Reserve	
<i>T11</i>	Reserve	
<i>Ft</i>	Target frequency	
<i>Fr</i>	Current frequency	
<i>IF</i>	Main EEV opening	
<i>2F</i>	Auxiliary EEV opening	
<i>od</i>	Operation mode	1 : cooling 4 : heating
<i>Pr</i>	Fan speed	AC - 1:H 2:M 3:L DC - value*10
<i>dF</i>	Defrosting condition	
<i>OIL</i>	Oil return situation	
<i>r1</i>	Reserve	
<i>r2</i>	Bottom heater switch	
<i>r3</i>	Reserve	
<i>STF</i>	4 way valve switch	
<i>HF</i>	Reserve	
<i>PF</i>	Reserve	
<i>PTF</i>	Reserve	
<i>Pu</i>	Water pump switch	
<i>RH</i>	AC fan H speed switch	
<i>Rd</i>	AC fan M speed switch	
<i>RL</i>	AC fan L speed switch	
<i>dCU</i>	DC bus voltage	
<i>dCC</i>	Inverter compressor current(A)	
<i>RcU</i>	Input voltage	
<i>RcC</i>	Input current	
<i>HE1</i>	History error code	
<i>HE2</i>	History error code	
<i>HE3</i>	History error code	
<i>HE4</i>	History error code	
<i>Pr</i>	Protocol version	
<i>Sr</i>	Software version	

9. ANNEX

9. 2. System parameter query

Keep pressing  3 s until you enter the settings

Code	Name	Range	Default
L0	Water pump working mode	0: ON constantly 1: OFF 60s after compressor off,Pump ON 5 min Per L1 min.	1
L1	Water pump working period	In standby mode,water pump work 5 min per L1 min. L1=3~180	30
L2	Timer setting	0: Timer function OFF 1: Timer function ON	1
L3	Power OFF remember function	0=OFF 1=ON	1
L4	Background light setting	0: No background light 1: light ON constantly 2: light on if operating, light off if no operation	2
L5	Unit operation mode	Range : 0-3 0=Heating only 1=Cooling only 2=Heating&cooling 3=Cooling/heating/auto/quick heating/Silence heating mode/quick cooling/ silence cooling mode	3

9. 3. Factory parameter query

Keep pressing  +  until you enter parameter verification mode and enter code 1688.

N°	Description	Range	Default	Remarks
H0	Accumulate heating operation time	30~120	45min	Adjustable
H1	Defrosting maximum speed	1~25	12min	Adjustable
H2	Stop defrosting temperature	1~25	12°C	Adjustable
H3	Start defrosting temperature	-20~20	-1°C	Adjustable
F0	Heating temperature difference before start	0°C~18°C	0°C	Adjustable
F1	Heating temperature difference before stop	0°C~18°C	2°C	Adjustable
F2	EEV adjust period	10~60 s	30s	Adjustable
F3	Cooling temperature difference before start	0°C~18°C	0°C	Adjustable
F4	Cooling temperature difference before stop	0°C~18°C	2°C	Adjustable
P0	Compensate temperature	-9~9°C	0°C	Adjustable
P1	Reserve			Reserve
P2	Reserve			Reserve
P3	Minimum working temperature	-19~15°C	-8°C	Adjustable
P4	Minimum ambient temperature difference	2~18°C	2°C	Adjustable
P5	Reserve			Reserve
P6	Auxiliary heater	On / Off	OFF	
P7	Temperature auxiliary heater start	2~15°C	5°C	Adjustable
P8	Temperature difference between inlet and outlet protection	2~60°C	10°C	Adjustable
P9	Bottom plate heater temperature start	-9~10°C	0°C	Adjustable
P10	High fan speed		83	Fixed value
P11	Mid fan speed		68	Fixed value
P12	Low fan speed		52	Fixed value

9. ANNEX

N°	Description	Range	Default	Remarks
P 13	Reserve			
P 14	Reserve			
P 15	Reserve			
P 16	Reserve			
P 17	EEV Maximum opening	50~480	480P	Adjustable
P 18	EEV Minimum opening	50~300	80P	Adjustable
P 19	Reserve			
P20	Forced recycle refrigerant	OF: OFF ON: ON	OF	Adjustable
P22	Heating maximum setting temperature	35~60°C	40°C	Adjustable
P23	Heating minimum setting temperature	15~25°C	15°C	Adjustable
P24	Cooling maximum setting temperature	25~35°C	28°C	Adjustable
P25	Cooling minimum setting temperature	2~10°C	8°C	Adjustable
C0	Test mode	On / Off	Off	
C1	Test mode compressor manually	10~120	50Hz	
C2	Test mode EEV manually opening	60 ~ 480	350P	
C3	Test mode fan speed	1 ~ 150 AC: 1:H, 2:M, 3:L DC: value*10 Range: 300~1500	82	

9. ANNEX

9. 4. Wiring diagrams

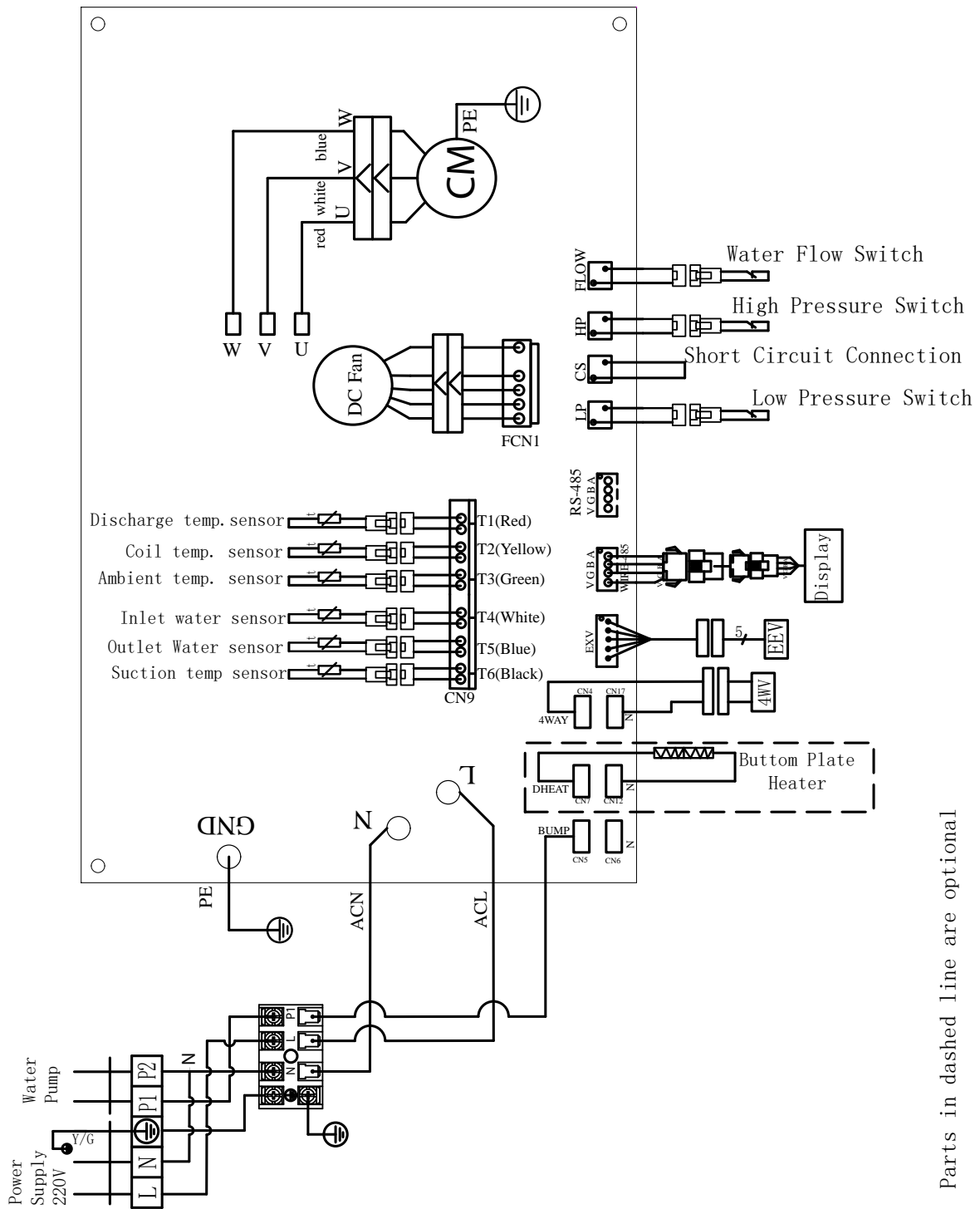

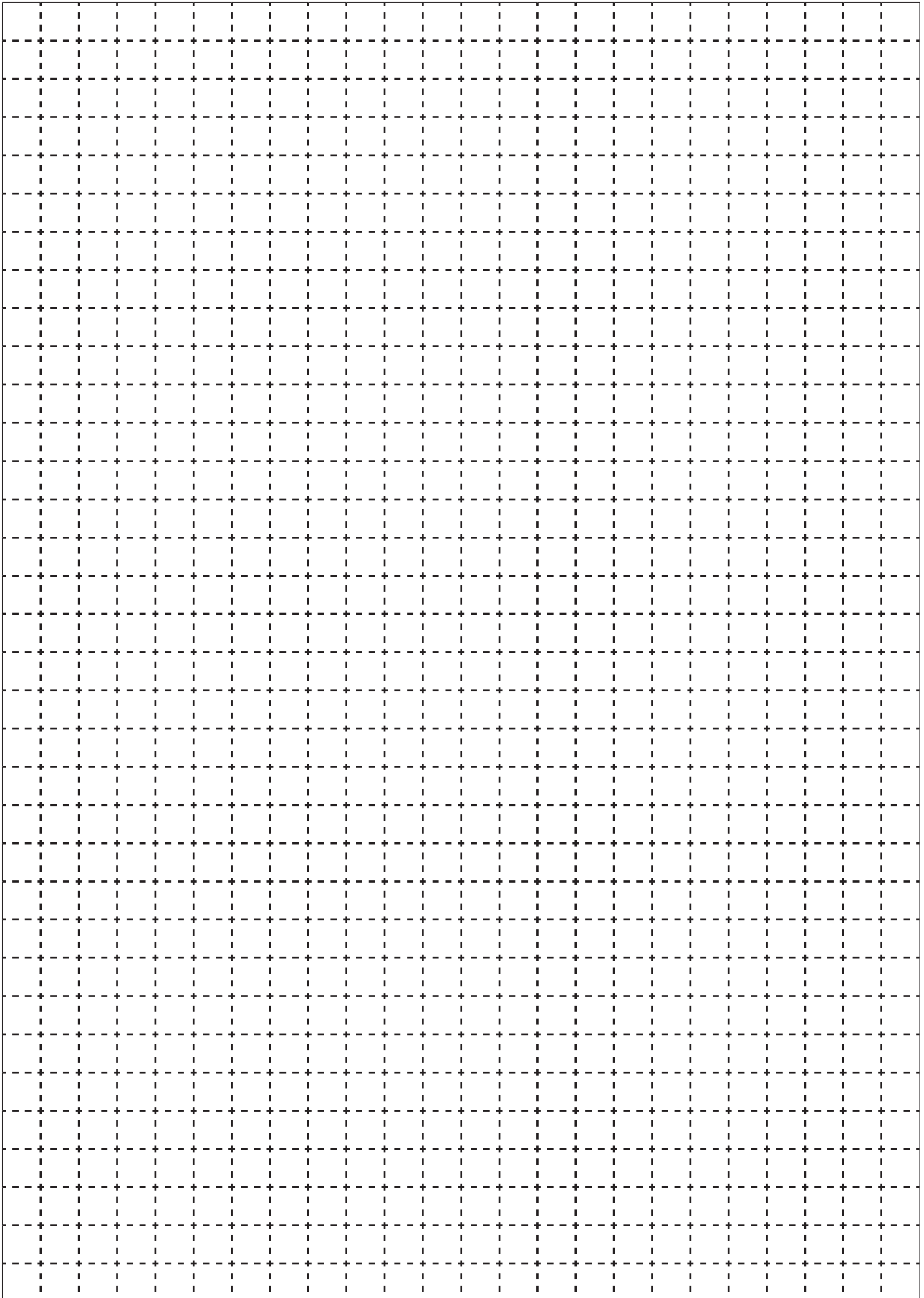

POOLEX



SCAN FOR MORE INFO

TECHNICAL ASSISTANCE
www.assistance.poolstar.fr

Poollex is a brand of the group

