



France Sauna

# Installation handbook

Steam Sauna



*Read this manual carefully before using your sauna for the first time.  
We recommend you keep it in a safe place for future reference.*

# SOMMAIRE

ENGLISH	P.
Warnings	2
Safety instructions	4
Description - Package contents and product presentation	6
Installation - Choice of location	7
Electrical connection	8
Cabin assembly	10
Rectangular model	10
Angular Model	16
Model 2 benches	20
Model 3 benches	26
Maintenance - Troubleshooting Guide	32
Maintenance - Guarantee	33

# RECOMMENDATIONS

- Install the sauna on a perfectly flat floor.
- The sauna must remain in a dry area.
- Do not use it near a source of water (bath, damp floor, swimming pool).
- Do not use liquid cleaning products.
- Disconnect the sauna before cleaning and use a wet rag. (see Maintenance section)
- Protect the sauna's electrical cable to avoid it being crushed or pinched.
- Prior to replacing certain components, ensure that they are specified by the manufacturer or that they have the same features as the original parts. Incorrect replacement can cause a fire, a shortcircuit or damage to the sauna. We strongly recommend using a qualified technician.
- To avoid the risk of burns or electric shocks, do not use any metal tools.
- Do not put animals in the sauna.
- Do not leave the sauna switched on without supervision.
- Do not leave the sauna switched on for more than 3 hours at a time to avoid premature deterioration of the equipment. After 3 hours continuous usage, switch off the sauna for at least one hour.
- We recommend that you do not install a locking system on the sauna door.
- Check compliance of your electrical installation prior to connecting your sauna to the power supply.

# SAFETY INSTRUCTIONS

**IMPORTANT** : Please read the safety instructions carefully before installing and using your sauna cabin.

**They are essential for your safety, so please adhere strictly to them.**

Beware of hyperthermia, heat stroke or heat exhaustion which can be caused or aggravated by noncompliance

with the safety instructions. Symptoms are fever, a rapid pulse, dizziness, fainting, lethargy and numbness in all or part of the body. The effects are: reduced awareness of the heat, ignorance of

imminent risks, loss of consciousness.

The sauna must not be used by :

- Children under 6 years of age.
- People with severe reactions to sunlight.
- Elderly or disabled people.
- People with previous medical conditions such as heart disease, high or low blood pressure, blood circulation problems or diabetes without prior medical advice.
- Pregnant women
- Excessive temperature can endanger the foetus.
- Persons suffering from dehydration, open sores, eye disorders, burns or sunstroke.

In the event of problems involving health, medication or injury to muscles or ligaments, do not use the sauna without previously consulting a doctor and obtaining approval.

If surgical implants are worn, do not use the sauna without previously consulting a doctor and obtaining his approval.

Do not use the sauna after strenuous activity.

Wait 30 minutes for your body to cool down.

Do not spend more than 40 minutes in the sauna at any one time.

Do not consume alcohol or drugs before or during the session.

Do not sleep in the sauna when it is in operation.

To avoid the risk of overheating, connect your sauna to a sufficiently powerful electrical outlet and do not connect other electrical equipment to the same wall socket.

To avoid any risk of electrocution or damage to the sauna, do not use it:

- During thunderstorms.
- If the electrical cable is damaged, it must be replaced by a qualified person.
- If the electrical cable overheats, it must be checked by a qualified person.
- If you have to change a bulb, wait until the sauna is switched off and cooled down.

Dry your hands before connecting or disconnecting the electricity.

Never work with wet hands or feet.

Do not switch the electricity or the heating system rapidly on or off as this could damage the electrical system.

Do not try to repair the sauna by yourself without the agreement of the sauna's distributor or manufacturer.

Unauthorised attempts to repair it will invalidate the manufacturer's warranty.

Do not use any type of detergent inside the sauna.

- Do not pile up or store objects inside or on top of the sauna.

Do not place flammable materials or chemical agents near the sauna.

# DESCRIPTION

## General features

- Cabin made from Canadian spruce
- Interior light fittings
- Thermometer/Hygrometer
- Hourglass
- Wooden pail and ladle
- Ventilation grille
- 2 year electronic warranty, 4 year wood warranty

## Certifications



Complies with current European standards.



Manufacturing process uses no heavy metals.

## Package contents

*General :*

- 1 x installation & user handbook
- 1 x door handle (interior and exterior component)
- 1 x electric stove protective cage
- 1 x steam sauna accessories pack (including thermometer, hygrometer, hourglass, pail, ladle and light fitting)

*Specific :*

- A. Ceiling
- B. Side or Rear
- C. Front + Door
- D. Seating
- E. Seating support
- F. Floor

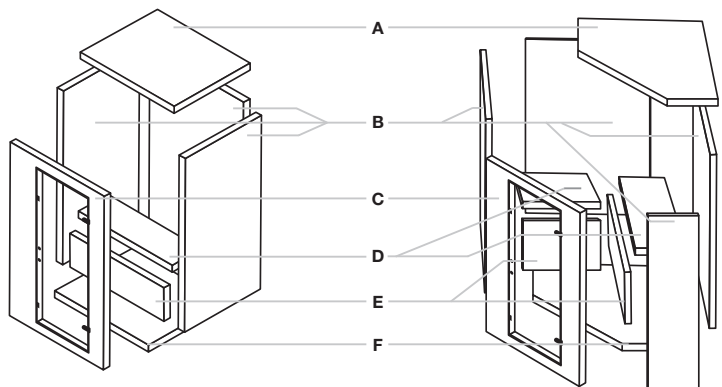

\*refer to stove technical guide for additional information.

# INSTALLATION

*Specific :*

- A. Ceiling
- B. Side or Rear
- C. Front + Door
- D. Seating
- E. Seating support
- F. Floor

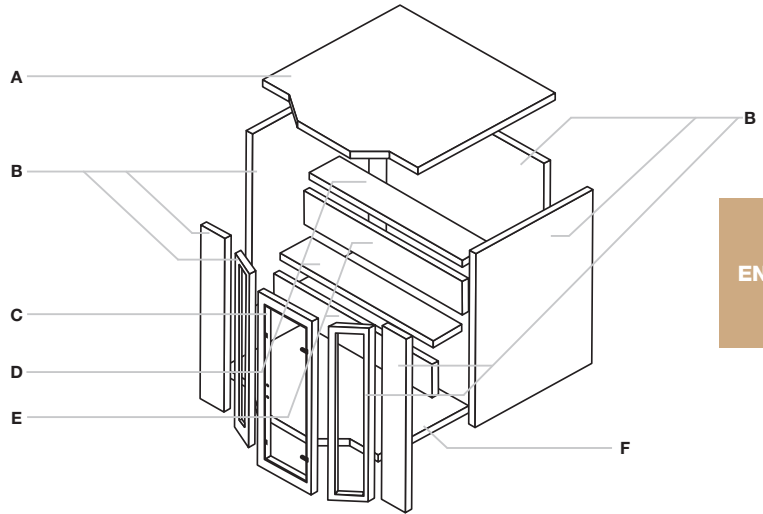

EN

*Read the assembly instructions carefully before starting.*

## Choice of location

Sauna-Center saunas are designed solely for interior installation.

Select a space:

- Inside, in a dry area, on a flat stable floor that can support the weight of your sauna.
- The height must be sufficient for you to reach the ceiling and carry out electrical connections and maintenance.
- Away from any source of water, flames or flammable materials.

## Practical advice:

- Note that sauna assembly requires two or three adults.
- Clearly identify each panel before you begin.
- During assembly, position your sauna's mains cable so that it is easily accessible.
- Note that there are variations between the models.

# INSTALLATION

Read the assembly instructions carefully before starting assembly.

## Electrical connections

The electrical installation of the stove must be carried out by a professional and sized according to the power of the stove. The stove is thus connected with its own electric line, not supplied as it depends on your installation.

This installation must be planned before mounting the cabin.

The entire internal electrical installation of the sauna (lights, LEDs, etc.) is connected directly to the electric stove, the electric cables being pre-wired within the cabin.

## Electrical sizing:

Power of the stove (kW)	Sauna volume (m <sup>3</sup> )		Electrical connection			
			230V 1N	Fuse	400V 3N	Fuse
4,5	3	6	3 x 2,5	1 x 20	5 x 1,5	3 x 10
6	5	8	3 x 2,5	1 x 35	5 x 1,5	3 x 10
8	7	12	3 x 6	1 x 35	5 x 2,5	3 x 16
9	8	14	3 x 10	1 x 50	5 x 2,5	3 x 16

Electrical connection for Harvia Vega stove

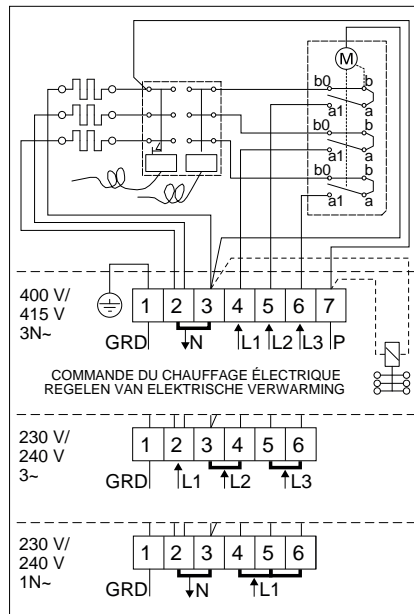

# INFORMATION

## Ignition and delayed start:

### Zone A

operation from 1 to 4 hours

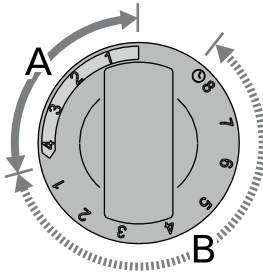

### Zone B

Delayed departure from 0 to 8 a.m.

## General explanations on the operation of the Harvia stove:

The temperature rise in the sauna is done in stages. A booth takes on average 30 to 45 minutes to reach a temperature of 65-70 ° C. During this period, the lava stones store heat.

To reach higher temperatures, it is necessary to add water to the stones. The steam thus generated will allow a gradual and measured increase in temperature.

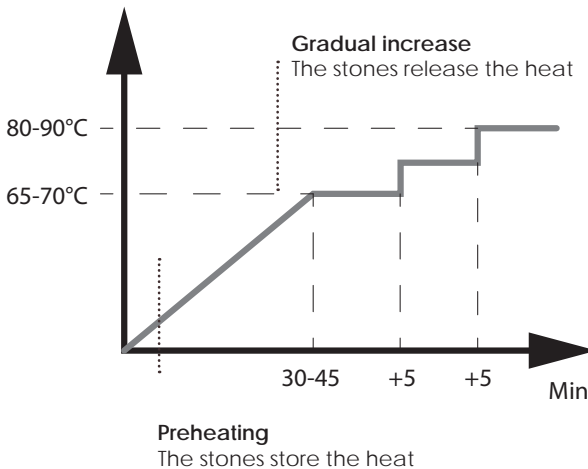

# RECTANGULAR MODEL



## Step 1

---

Start by positioning the flooring on the ground at the location where you wish to install the sauna.



## Step 2

---

Install the rear panel in the groove in the flooring.

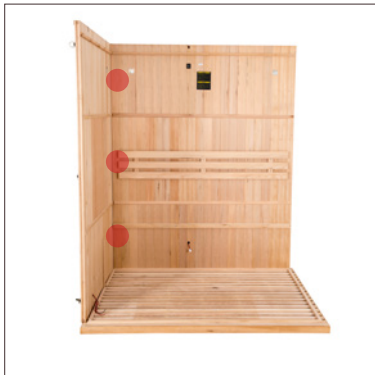

## Step 3

---

Position the left side panel in the groove in the flooring, ensuring that it slots perfectly into the rear panel.

Finish the assembly of two panels by locking buckles.

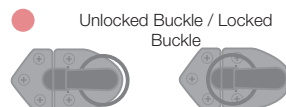

# ASSEMBLY

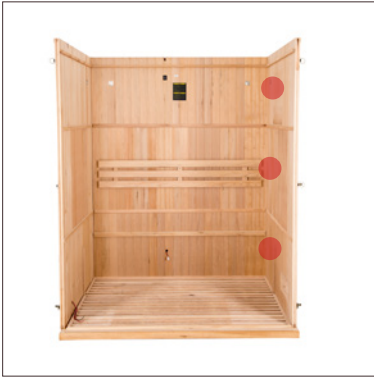

## Step 4

Position the front panel in the groove in the flooring, ensuring that it slots perfectly into the left side panel. Important: Keep the door closed while handling this component.

Finish the assembly of two panels by locking buckles.

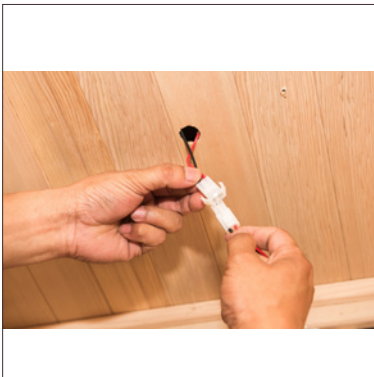
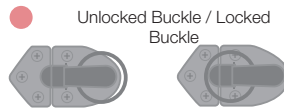

## Step 5

Connect the LED and light connections under the benches. The lights are integrated into the bench seat and connect directly to the roof.



## Step 6

Position the vertical part of the bench

# RECTANGULAR MODEL



## Step 7

Position the white seat on its supports



## Step 8

Position the front panel in the groove in the floor, making sure it fits snugly with the left side panel. Be careful, keep the door closed when handling and that the buckles are aligned

Finalize the assembly of the 2 panels by locking the buckles.

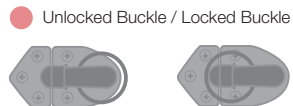

## Step 9

Position the roof above the cabin, taking care to pass the connections through the passages provided.

# ASSEMBLY



## Step 10

---

Install the high luminaires by first inserting the connection cables to the roof.

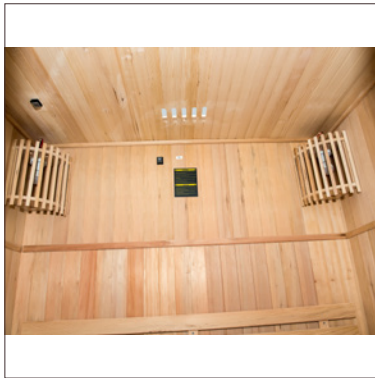

## Step 11

---

Repeat the operation on the second luminaire.

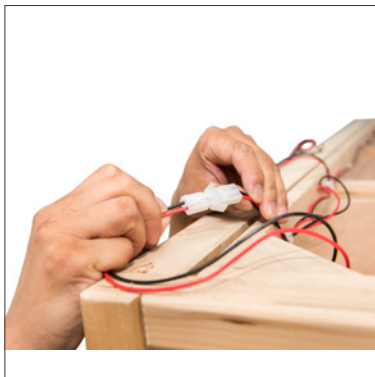

## Step 12

---

Connect all the lights to the cables already on the roof. You must connect the 2 top lights, the LED strips for chromotherapy as well as the light under the bench.

# RECTANGULAR MODEL



## Step 13

Add the gasket to the inside of the door, on the hinge side.

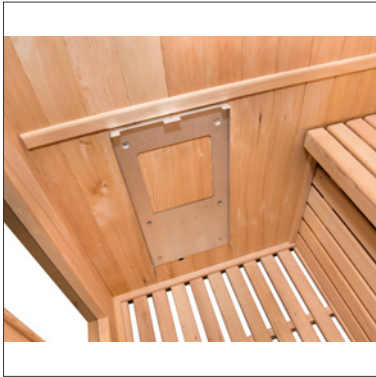

## Step 14

Screw the stove support in the intended location.

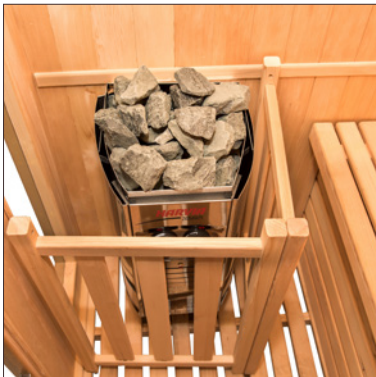

## Step 15

Connect the stove electrically as well as the electric elements of the cabin, then install it and add the stones on top evenly.

Do not drop stones into the stove.

Do not trap the stones between the resistors.

The stones should not be too tight, they should support each other without resting on resistance.

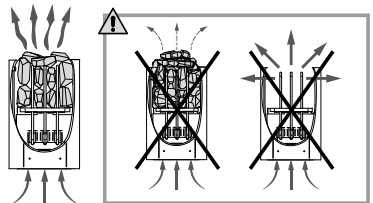

# ASSEMBLY

## Step 16

---

You can now install the supplied steam accessories and fully enjoy your steam cabin.

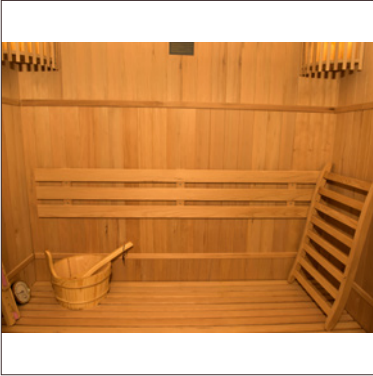

# ANGULAR MODELS



## Step 1

---

Start by positioning the flooring on the ground at the location where you wish to install the sauna.



## Step 2

---

Position the first back panel on the outside of the floor.



## Step 3

---

Position the second rear panel and reattach it with the first. They must fit together perfectly.

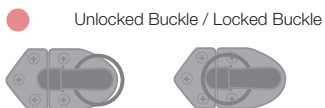

# ASSEMBLY



## Step 4

Now assemble the front facade by joining the 2 walls and keeping the door closed.

● Be sure to insert the right side panel securely into the interior latches on the front panel.



EN



## Step 5

Now assemble the third facade to the other two, already assembled.

Finalize the assembly of the 2 panels by locking the buckles.

● Be sure to insert the right side panel securely into the interior latches on the front panel.

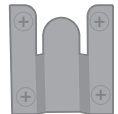

## Step 6

Now present the entire front facade to the rest of the structure, making sure that the floor fits perfectly with the facade. Then lock with the 6 buckles.

Finalize the assembly of the 3 panels by locking the buckles.

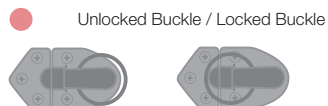

# MODÈLES ANGULAIRE

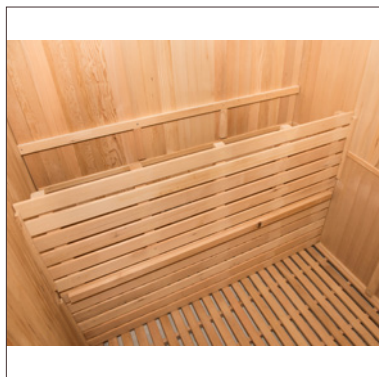

## Step 7

---

Now position the vertical part of the upper bench in its notches



## Step 8

---

Position the top bench support, making sure it fits snugly with the side panels.



## Step 9

---

Position the lower bench, making sure it fits snugly with the side panels.

# ASSEMBLAGE

EN



## Step 10

Install the roof panel making sure it fits snugly into all of the side panels.



## Step 11

Install the high luminaires by first inserting the connection cables to the roof.



## Step 12

Connect the stove electrically as well as the electric elements of the cabin, then install it and add the stones on top evenly.

Do not drop stones into the stove.

Do not trap the stones between the resistors.

The stones should not be too tight, they should support each other without resting on resistance.

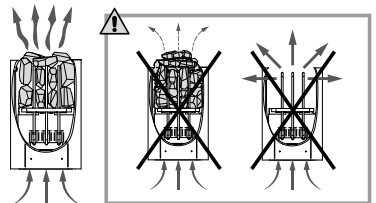

22

# MODÈLE 2 BANQUETTES



## Step 1

Start by positioning the back panel.



## Step 2

Position the side panel at a right angle.

Finalize the assembly of the 2 panels by locking the buckles.

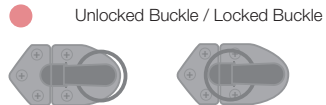

## Step 3

Position the third side panel.

Finalize the assembly of the 2 panels by locking the buckles.

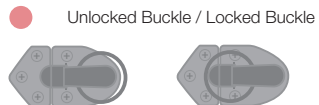

# ASSEMBLAGE



## Step 4

---

Position the vertical part of the upper bench in its notches, then the vertical part of the lower bench. Make sure that the panels fit well with the side panels.



## Step 5

---

Position the support of the upper bench, then the lower bench, checking that it fits perfectly to the side panels.



## Step 6

---

Position the floor by sliding it from below, and being careful not to damage the cables.

# MODÈLE 2 BANQUETTES



## Step 7

---

Now assemble the front of the sauna. Start with the central part including the door.

Be sure to insert the right front panel securely into the interior latches on the front panel.



## Step 8

---

Then assemble the other part of the facade.

Be sure to insert the right front panel securely into the interior latches on the front panel.



## Step 9

---

Finalize the assembly of the facade with the last 2 left and right panels.

Be sure to insert the right front panel securely into the interior latches on the front panel.



# ASSEMBLAGE



## Step 10

---

Join the facade elements to the rest of the cabin structure and assemble them together.

Complete the assembly of the left front panel with the left side panel by locking the buckles.

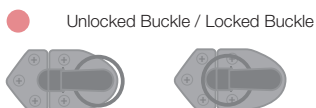

EN



## Step 11

---

Now install the sauna roof, taking care to pass the cables through the grooves provided.



## Step 12

---

Install the high luminaires by first inserting the connection cables to the roof.

# MODÈLE 2 BANQUETTES

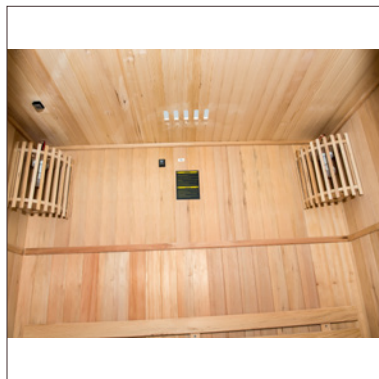

## Step 13

---

Repeat the operation on the second luminaire.

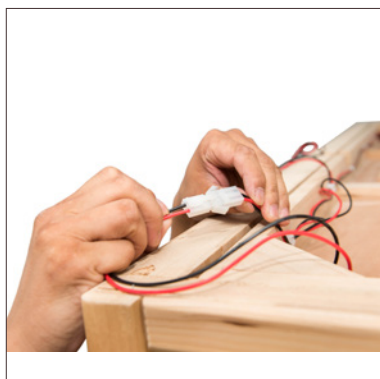

## Step 14

---

Connect all the lights to the cables already on the roof. You must connect the 2 top lights, the LED strips for chromotherapy as well as the light under the bench.

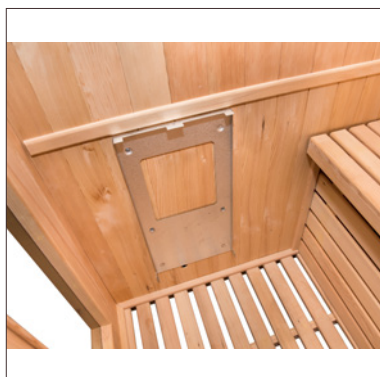

## Step 14

---

Screw the stove support in the intended location.

# ASSEMBLAGE

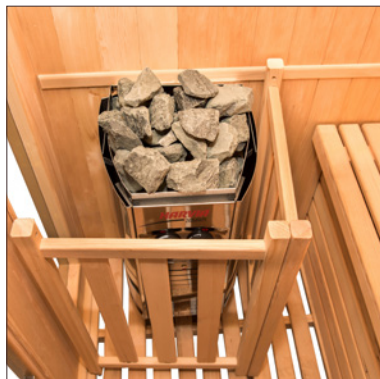

## Step 15

Connect the stove electrically as well as the electric elements of the cabin, then install it and add the stones on top evenly.

Do not drop stones into the stove.

Do not trap the stones between the resistors.

The stones should not be too tight, they should support each other without resting on resistance.

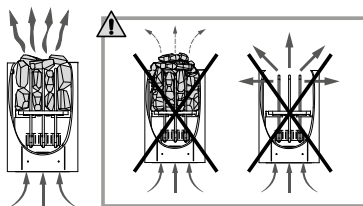

# MODÈLE 3 BANQUETTES



## Step 1

---

Start by positioning the floor on the floor where you want to install the sauna.



## Step 2

---

Install the back panel into the groove in the floor. Making sure to hold the panel properly.



## Step 3

---

Position the side panel in the groove in the floor making sure it fits snugly with the back panel while aligning the loops.

Finalize the assembly of the 2 panels by locking the buckles.

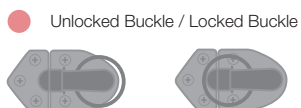

# ASSEMBLAGE



## Step 4

Position the front panel in the groove in the floor, making sure it fits snugly with the left side panel. Be careful, keep the door closed when handling and that the buckles are aligned

Finalize the assembly of the 2 panels by locking the buckles.



EN



## Step 5

Connect the LED and light connections under the benches



## Step 6

Position the vertical parts of the upper and lower benches.

# MODÈLE 3 BANQUETTES



## Step 7

Position the white seats on their supports, checking that they join the side walls well.



## Step 8

Position the front panel making sure that the connections with the side panels join correctly. Be careful, keep the door closed when handling and that the buckles are aligned

Finalize the assembly of the 2 panels by locking the buckles.

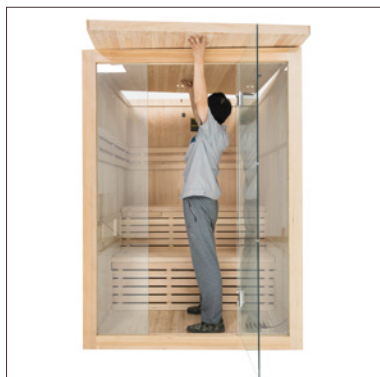

## Step 9

Position the roof above the cabin, taking care to pass the connections through the passages provided.

# ASSEMBLAGE



## Step 10

---

Position the third bench in the notches and check its stability.



## Step 11

---

Install the high luminaires by first inserting the connection cables to the roof.

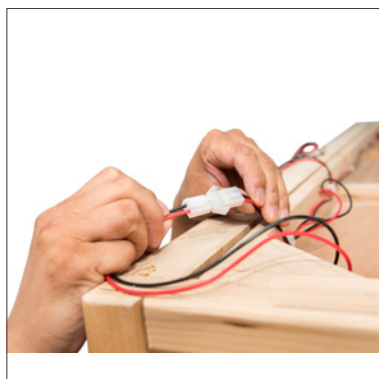

## Step 12

---

Connect all the lights to the cables already on the roof. You must connect the 2 top lights, the LED strips for chromotherapy as well as the light under the bench.

# MODÈLE 3 BANQUETTES

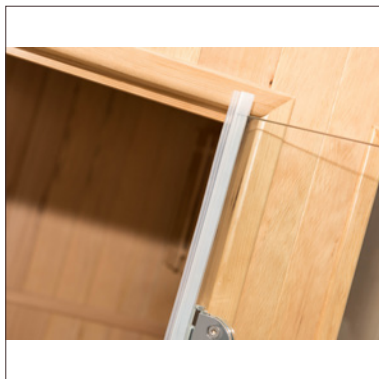

## Step 13

Add the gasket to the inside of the door, on the hinge side.

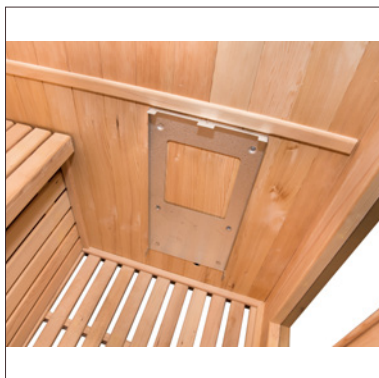

## Step 14

Screw the stove support in the intended location.

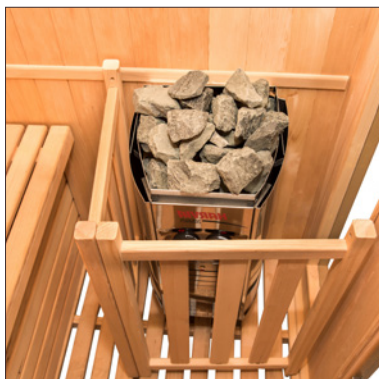

## Step 15

Connect the stove electrically as well as the electric elements of the cabin, then install it and add the stones on top evenly.

Do not drop stones into the stove.

Do not trap the stones between the resistors.

The stones should not be too tight, they should support each other without resting on resistance.

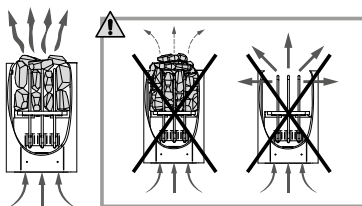

# ASSEMBLAGE

## Step 16

---

You can now install the supplied steam accessories and fully enjoy your steam cabin.

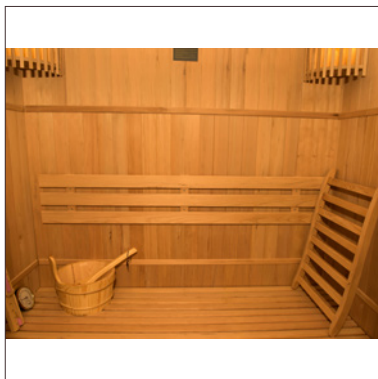

# MAINTENANCE

Disconnect the cabin's power supply cable before undertaking any work.

Problems identified	Possible reasons	Solutions
Electric stove does not heat up.	Power supply cable disconnected	Check power supply cable connection
	The general power supply is cut	Check that the switchboard and wall plug are working
	Stove is overheat protected.	Refer to the electric stove manual
Sauna light fittings no longer work	Bulb not fully engaged	Check bulb holder and replace if necessary
	Bulb is defective	Replace bulb
	Light fitting is disconnected from the stove	Disconnect the stove's power supply then check the connection

# SERVICING & WARRANTY

## Servicing

1. Disconnect your sauna.
2. Use a vacuum cleaner to remove dust from crevices in the woodwork.
3. Clean the cabin with a damp cotton cloth and use a small amount of soap if necessary. Rinse with a damp cloth.
4. Wipe with a dry cloth.

### IMPORTANT

Do not use benzene, alcohol, chemical agents or strong detergents on the sauna since chemical products can damage the wood and its protective coating. Do not spray water on your sauna.

### Practical advice:

To extend the life of your sauna, we recommend that you apply linseed oil to the benches, back rests and flooring of your cabin with a lint-free cloth.

If your sauna's flooring or bench are indelibly marked, rub them lightly with sandpaper.

## Warranty

All the components of France-Sauna saunas are guaranteed for 2 years and wood 4 years..

The warranty comes into force on the date of dispatch (corresponding to the date the invoice is issued).

The warranty does not apply in the following cases :

- Malfunction or damage arising from installation, usage or repair that are not in compliance with the safety instructions.
- Malfunction or damage arising from conditions that are unsuitable for the equipment's originally intended purpose.
- Damage arising from negligence, accident or force majeure (thunderstorm or bad weather).
- Malfunction or damage arising from the use of non-authorized accessories.

The warranty does not cover the costs linked to returning the cabin or part of its components to our workshops of. Under the warranty, in the event of a breakdown, the items deemed defective by our technicians will be exchanged. Information and explanations required for their installation will be provided by one of our technicians. Costs linked to the use of subcontract labour provided by a third party cannot be covered by France-sauna.



# France Sauna

CE

TECHNICAL ASSISTANCE

[www.france-sauna.com](http://www.france-sauna.com)



POOLSTAR Group | [www.poolstar.fr](http://www.poolstar.fr) | 960 avenue Olivier Perroy, 13790 ROUSSET FRANCE