













POOLEX

TURBO-SALT

-  Electrolyseur au sel Pour Piscine
-  Swimming Pool Salt Chlorinator
-  Clorador salino para piscinas
-  Elettrolizzatore al sale per piscine
-  Salz-Elektrolysegerät für Schwimmbecken
-  Elektrolysetoestel met zout voor zwembad
-  Eletrolisador de sal para piscina



-  Manuel d'installation et d'utilisation
-  Installation and user manual
-  Manual de usuario y instalación
-  Manuale d'installazione e d'uso
-  Installations und Gebrauchsanleitung
-  Installatie en gebruikershandleiding

! PLEASE READ CAREFULLY !

These installation instructions form an integral part of the product.

They must be given to the installer and kept by the user.

If you lose this manual, please visit our website:

www.poolex.fr

The warnings and guidelines contained in this manual must be carefully read and understood as they provide important information concerning the safe handling and operation of the chlorinator. **We recommend that you keep this manual handy for future reference.**

Installation must be performed by a qualified professional in accordance with regulations in force and the manufacturer's instructions. Errors made during installation can cause physical injuries to people and animals as well as mechanical damage for which the manufacturer shall not be held liable.

After unpacking the chlorinator, please check the contents for any damage.

Before plugging in the chlorinator, ensure that the instructions provided in this manual are compatible with actual installation conditions and do not exceed the maximum authorised limits for the product in question.

In the event of a defect and/or malfunction, electrical power must be switched off and no attempts to repair the fault should be made. Repairs must be carried out by an authorised technician using original spare parts. Non-compliance with the aforementioned clauses can negatively impact the safe operation of the chlorinator.

In order to guarantee the efficiency and proper functioning of the chlorinator, it must be regularly maintained in accordance with the instructions provided.

In the event the chlorinator is sold or transferred to another party, please ensure that all technical documentation is given to the new owner together with the equipment.

This chlorinator is designed exclusively to treat swimming pools. Any other use is considered inappropriate, incorrect and potentially dangerous.

All contractual and extra-contractual liability on the part of the manufacturer / distributor shall be considered null and void in the event of damage caused by errors in the installation or operation, or due to non-compliance with the instructions provided in this manual and standards in force for the installation of equipment discussed in this document.

TABLE OF CONTENTS

1	– Safety instructions	23
2	– Description	24
◆	How it works	24
◆	Operating limits	24
◆	Recommended rate tables	25
◆	Features	25
◆	Technical specifications	26
◆	Dimensions (in mm)	26
3	– Installation	27
◆	Preliminary operations	27
◆	Hydraulic connection case 1 : Using D50mm PVC pipes	27
◆	Hydraulic connection case 2 : Using D38mm or D32 pipe	28
◆	Electrical connection	28
4	– Adding salt	29
◆	Warnings	29
◆	Required salt levels	29
◆	Quick reference table for adding salt in Kg	30
◆	Quick reference table for adding salt in pounds	31
◆	Process for adding salt	31
5	– Use of control panel	32
◆	Overview of control panel	32
◆	Selecting operating modes	33
6	– Useful tips	34
◆	General principles	34
◆	List of recommended actions:	34
◆	List of prohibited actions:	34
7	– Cleaning the cell	35
◆	Principle	35
◆	Disassembly	35
◆	Cleaning	35
8	– Winterizing	36
◆	Active winterizing	36
◆	Passive winterizing	36
◆	Restarting in spring	36
9	– Troubleshooting	37
◆	Performing system checks	37
◆	Special case: hard water	38
◆	Replacing the cell	38
◆	List of error codes and their solutions	38
10	– Warranty	40

SAFETY INSTRUCTIONS

Installation and maintenance of any upstream electrical components must be performed by a qualified electrician. Failing to do so may result in electric shock, serious injury, property damage and even death.

Prior to any maintenance or operation, ensure that the salt chlorinator and any other devices are shut down and the main power supply is off.

The salt chlorinator's external power adaptor must be connected to a main power supply separate from the filtration system (no feedback control), equipped with a 30mA residual current device and an earthing system.

The salt chlorinator must be plugged into an outlet located in a well-ventilated area to prevent overheating. Do not plug the salt chlorinator into an outlet where it could be damaged by humidity or rain.

The person responsible for installing the chlorinator must carefully read this manual. In the event of a malfunction or erroneous operation, please contact the nearest authorised reseller or technical support.

If a part is damaged, ensure a replacement is purchased from the manufacturer or an authorised reseller.

NOT COMPLYING WITH THESE WARNINGS CAN RESULT IN PROPERTY DAMAGE, ELECTRIC SHOCK, COMPLICATIONS OR OTHER SERIOUS INJURIES AND EVEN DEATH.

WARNING - TO AVOID THE RISK OF INJURY, DO NOT ALLOW CHILDREN TO OPERATE THIS DEVICE.

WARNING - INTENSIVE USE OF THE POOL (OR SPA) OR HIGH TEMPERATURES MAY REQUIRE AN INCREASED LEVEL OF CHLORINE PRODUCTION IN ORDER TO MAINTAIN ADEQUATE LEVELS OF FREE CHLORINE.

IF USED IN AN INDOOR SWIMMING POOL, UNDER COVER OR COVER, CHECK THE CHLORINE LEVEL REGULARLY (< 2PPM) AND VENTILATE REGULARLY.

DESCRIPTION

HOW IT WORKS

Salt chlorination of a pool works by using salt electrolysis to disinfect the water; this electrochemical process converts the salt present in the water into a disinfectant (hypochlorite ions).

Once this process is complete, hypochlorite turns back into salt after coming into contact with organic material (bacteria, cells) or under the effect of UV rays or other sources of light, starting the cycle over again.

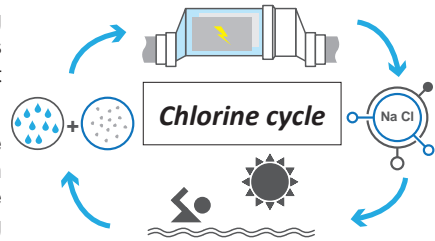

In order to maintain a good level of disinfectant in the water, the following guidelines must be respected:

- A proper concentration of salt in the water: 3 g/l
- Adequate filtration time. As a reminder, a good estimate is:

$$\text{Filtration Time} = T^\circ \text{water} / 2$$

- A good water balance with a pH between 7.0 and 7.8 (for more information see Taylor watergram)
- Regular cleaning of your pool to remove any plant debris
- In case of frequent use, consider using the boost function.

WARNING - SALT WATER CHLORINATION ALONE WILL NOT CLEAR UP GREEN WATER BY ITSELF. IN THE EVENT OF ALGAE APPEARING (E.G. AFTER A PERIOD OF HIGH TEMPERATURES OR FREQUENT USE), IT MAY BE NECESSARY TO SUPPLEMENT WITH CHLORINE TABLETS. DO NOT PUT THE CHLORINE TABLETS DIRECTLY INTO THE SKIMMER; USE A FLOATING DISPENSER.

OPERATING LIMITS

The filtration time should be long enough to suit your pool. As with any swimming pool, take care to maintain a good chemical balance in the water, including pH, alkaline content and calcium levels.

The use of an electrolyzer requires maintaining good levels of salt and stabilizer to avoid corrosion or scaling. Check your water at least once a week to check the values of the basic parameters. For added safety, have the pool water tested by a professional at least twice a season.

Your pool shop can not only supply you with the chemicals you will need, but can also advise you on the procedures to follow to adjust the chemical properties of the water. Inform them that you are using a salt-based chlorinator.

Temperature also has a major effect on the correct use of the chlorinator:

- A water temperature below 10°C will render the system inoperative (E2 alarm).
- Water temperatures above 32°C will reduce the effects of hypochlorite. If these high temperatures persist, we recommend adding chlorine pebbles, not directly into the skimmer but rather into a floating diffuser.

DESCRIPTION

RECOMMENDED RATE TABLES

CHECK YOUR VALUES AND CORRECT THEM AT LEAST ONCE A WEEK.

Parameter	Target values	Comments
Salinity	3 to 4 g/l	Once the salt is dissolved in the water (+/- 24 to 48h), salt concentration will only vary slightly over the course of the season.
pH level	7.2 to 7.4	Please note, a pH above 7.8 suppresses the disinfecting properties of hypochlorite.
Free chlorine concentration	From 0.5 to 3.0 ppm	Measurements must be taken from around the return inlets when the chlorinator is switched on, preferably in the morning and out of direct sunlight.
! important ! Stabilizer rate (Cyanuric Acid)	From 20 to 50ppm	Hypochlorite is a relatively unstable disinfectant. With too low a level of stabilizer, the hypochlorite will turn back into salt too quickly without having had enough time to disinfect. Conversely, with too high a level of stabilizer, the hypochlorite will be blocked. Be careful, if the level of stabilizer is much too high, the pool will have to be partially drained to add water without stabilizer.
Additional tests		
Total alkalinity (TA)	From 80 to 150 ppm	This level measures the concentration of mineral salts (carbonates, bicarbonates, hydroxides) in the water. It stabilizes / buffers the water balance. High TA levels interfere with the effects of pH regulation and scale deposits may begin to appear.
Water hardness	From 150 to 300 ppm	Water hardness represents the amount of calcium carbonate present in your water.

CAUTION - THE PRESENCE OF IRON IN YOUR WATER (FERRUGINOUS WATER) MAY LEAD TO RUST DEPOSITS ON YOUR POOL AND REQUIRE THE USE OF A METAL SEQUESTERANT. PLEASE CONSULT TO A PROFESSIONAL ABOUT THIS.

FEATURES

The salt chlorinator contains the latest electronic monitoring technology for ease of use. You can easily adjust the production of disinfectant to suit your needs, maximizing efficiency while remaining environmentally friendly. In addition to these easy-to-use settings, it also has a self-cleaning function for the cell and a self-test mode in the event of a warning or error code.

For example, the chlorinator displays a warning when it detects low salinity levels, improper temperatures or a lack of water flow (see "List of error codes and their solutions", page 41).

The compact size of the chlorinator and its integrated control panel allows for easy installation and a smaller footprint. The water inlet and outlet are on the same axis, reducing the need to rearrange piping.

DESCRIPTION

TECHNICAL SPECIFICATIONS

Poollex Turbo Salt						
Model	100	200	300	400	600	800
Maximum volume treated (m ³)	10	20	30	40	60	80
Salt concentration (g/l)	3 à 4					
Input voltage (VAC)	230Vac/50Hz					
Output voltage (VDC)	12	24	24	24	24	24
Output current (A)	1,0	2,0	2,0	2,0	2,0	2,5
Hypochlorite production (g/h)	2	4	6	8	12	18
Min. flow rate in cell	2.5 m ³ /h				5 m ³ /h	
Max. flow rate in cell (m ³ /h) (above this level a bypass is required)	10 m ³ /h				15 m ³ /h	
Connectors supplied (2 types)	1,5" / D50 mm et D32/38mm					
Temperature sensor	YES					
Flow sensor	YES					
Cell maintenance	YES though reverse polarity (4h)					
Covered mode	YES (manual)					
BOOST mode	YES (2 BOOST levels)					

EN

DIMENSIONS (IN MM)

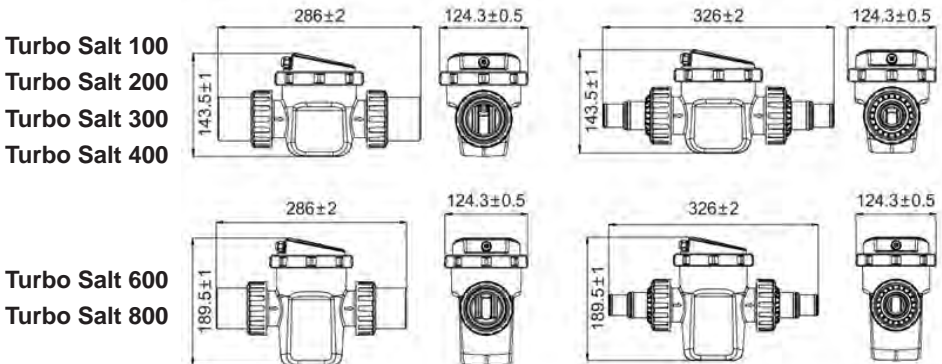

MIN



INSTALLATION

PRELIMINARY OPERATIONS

1. Ensure the electricity and water circulation system are switched off, and close the valves on the pipes connected to the chlorinator.
2. Ensure any pipes used (not supplied) are compatible with the chlorinator.
Dimensions of the 2 types of connectors supplied:
 - OPTION 1: 1.5" (metric: Ø50 mm) connectors to be sealed using PVC cement
 - OPTION 2: D32 or 38 mm push fit connectors
3. Remove any obstructions.
4. Lubricate the fittings.
5. Ensure the direction of water flow corresponds to the direction indicated on the chlorinator:
"←".

The salt chlorinator must be installed on the return line carrying water from the pool filter back to the return inlets, as shown in Figure 1 (horizontal assembly) and Figure 2 (vertical assembly). If using with a water heating system, install the chlorinator downstream from the latter. The chlorinator must be the final element of the circuit.

Installation without a bypass is possible if your pump has a flow rate of < 10m³/h, however, using a bypass is strongly recommended to allow the hydraulic circuit to be isolated. If the flow rate of your pump is > 10m³, a bypass is required.

HYDRAULIC CONNECTION CASE 1 : USING D50MM PVC PIPES

If you need to cut existing D50mm PVC pipe, the length of the cut must be 230 mm. Make sure to use special PVC cement for 1.5" (D50) connectors.

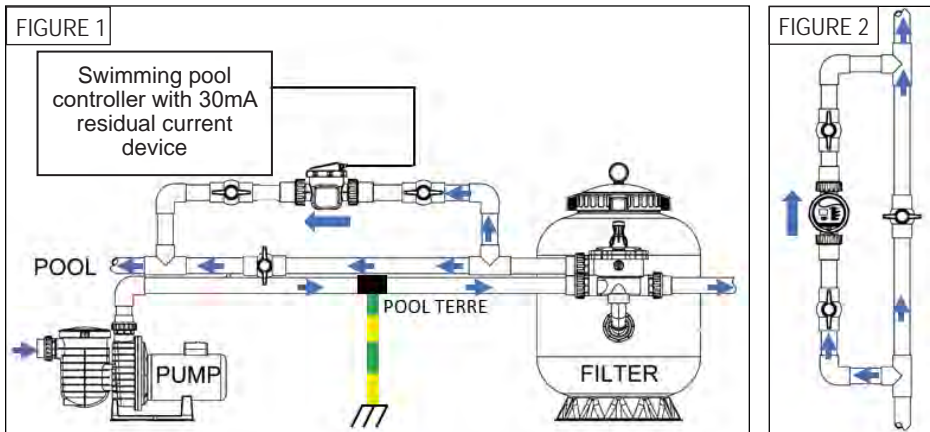

If you want to insert the chlorinator into an existing pipe (or fit on to a pipe), you must cut out a section measuring 230mm in length:



INSTALLATION

HYDRAULIC CONNECTION CASE 2 : USING D38MM OR D32 PIPE

When using this type of pipe, another length of pipe, minimum 50cm (not supplied), equivalent to the one in place must be added to the outlet of the filter; consider adding a valve (if not already present) just after the chlorinator to be able to isolate this section and facilitate maintenance.

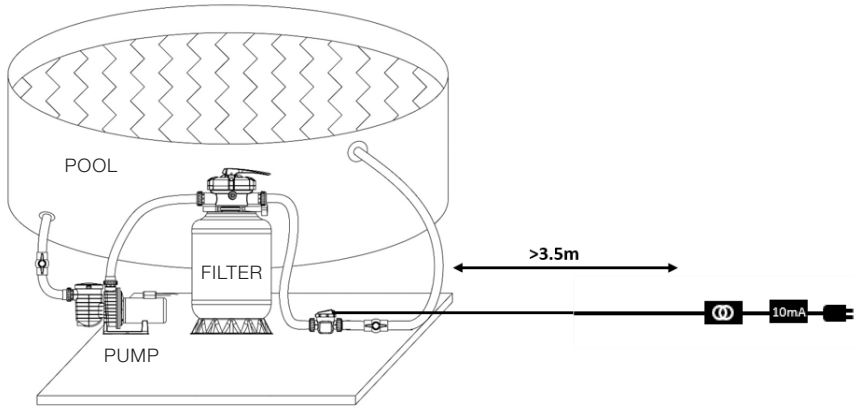



ELECTRICAL CONNECTION

The power supply of the salt chlorinator must be connected to a separate power source equipped with a 30mA residual current device, sheltered from the rain and at least 3.5 m away from the pool. In the event of tripping the residual current device, check system integrity before resetting. In case of doubt, contact a professional.

The salt chlorinator must be plugged into an outlet located in a well-ventilated area to prevent overheating.

Do not install in places where water can easily ingress to prevent damage to the electrical components caused by humidity or rain. A wall or floor mounting bracket is supplied (ref.: CL-TSLFIX).

Mounting bracket ref. CL-TSLFIX	Using the wall or floor mounting bracket
	

SUPPLEMENTARY ELECTRICAL BONDING (POOL EARTHING)

In order to protect the metal components (including stainless steel) in contact with the water of your pool, it is strongly recommended to install supplementary bonding (POOL EARTHING) (product ref. CL-POOLTERRE50 - not supplied) which is separate from the earthing system of your house in order to carry residual current from your pool equipment to the ground. This current can lead to serious galvanic corrosion. (Ground cable not supplied)



ADDING SALT

WARNINGS

BEFORE ADDING SALT, ALWAYS PERFORM A TEST TO MEASURE THE PRE-EXISTING SALT LEVELS (TEST STRIPS OR ELECTRONIC TESTER).

ONLY USE SALT WHICH COMPLIES WITH EUROPEAN STANDARD EN 16401 TO EXTEND SERVICE LIFE AND IMPROVE EFFICIENCY OF THE CHLORINATOR CELL.

DO NOT ADD CHEMICAL PRODUCTS OR SALT DIRECTLY INTO THE SKIMMER. THIS CAN DAMAGE THE CELL. IF THE CHLORINATOR CELL HAS ALREADY BEEN INSTALLED, DO NOT SWITCH ON BEFORE ADDING SALT AND ENSURE SALT IS COMPLETELY DISSOLVED.

IN SUMMER, SALT MAY TAKE 24 - 48 HOURS TO DISSOLVE, AND EVEN LONGER IN WINTER.

Do not place the plastic bag of salt into the water as the chemicals and inks on the bag can interfere with water balance. Make an opening in the bag, then empty its contents. Once the bag is empty, dispose in an appropriate receptacle or recycle if possible.

REQUIRED SALT LEVELS

The system can operate in a wide range of salinities, from a minimum of 2,700 ppm (parts per million) up to 4,500 ppm. However, **optimal salt concentration is around 3,000 ppm.**

To achieve this salinity level, add **around 3 kg of salt per 1m³ of water** (or 25 pounds of salt per 1,000 gallons of water).

Calculation of the amount of salt

$$\text{Amount of salt to add} = \text{Volume of water in m}^3 \times (3 - \text{current salt content in kg/m}^3)$$

TIP: WHEN ADDING LARGE QUANTITIES OF SALT, ALWAYS START BY TESTING THE SALINITY OF THE WATER AND GRADUALLY ADDING SALT, TESTING THE CONCENTRATION EACH TIME.

If you're unsure of the volume of your pool (m³), you can calculate it using the following equations:

- Rectangular pool: Length x Width x Average Depth
- Round pool: Diameter x Diameter x Average Depth x 0.80
- Oval pool: Length x Width x Average Depth x 0.90

If not enough salt is added, efficiency is reduced and the level of chlorine production will be too low. In addition, operating at low salinity levels will reduce the longevity of the cell.

The salt in your pool is constantly recycled, limiting the amount of salt lost during a bathing session.

Losses are mainly due to the addition of extra water replacing water lost as a result of splashes, run-off, filter cleaning and drainage.

ADDING SALT

Salt is not lost through evaporation.

IN THE EVENT OF EXCESS SALINITY (> 4.5 G/L), PARTIAL EMPTYING OF THE POOL MAY BE NECESSARY IN ORDER TO ADD FRESH WATER.

QUICK REFERENCE TABLE FOR ADDING SALT IN KG

<i>Salinity before adding salt (PPM) (1ppm=1kg/m³)</i>								
Volume in m³	0	500	1000	1500	2000	2500	3000	3500
<i>Amount of salt required (kg)</i>								
15	53	45	38	30	23	15	8	0
23	79	68	57	45	34	23	11	0
30	106	91	76	60	45	30	15	0
38	132	113	95	76	57	38	19	0
45	159	136	113	91	68	45	23	0
53	185	159	132	106	79	53	26	0
61	212	181	151	121	91	60	30	0
68	238	204	170	136	102	68	34	0
76	265	227	189	151	113	76	38	0
83	291	249	208	166	125	83	42	0
91	318	272	227	181	136	91	45	0
98	344	295	246	197	147	98	49	0
106	371	318	265	212	159	106	53	0
114	397	341	284	227	170	113	57	0
121	424	363	302	242	181	121	60	0
129	450	386	322	257	193	129	64	0
136	477	409	341	272	204	136	68	0
144	503	431	346	288	215	144	72	0
151	530	454	378	302	227	151	76	0
159	556	477	397	318	238	159	79	0
167	582	499	416	333	249	166	83	0
174	609	522	435	348	261	174	87	0
182	635	545	454	363	272	181	91	0
189	662	567	473	378	284	189	95	0

ADDING SALT

QUICK REFERENCE TABLE FOR ADDING SALT IN POUNDS

<i>Salinity before adding salt (PPM) (1ppm=1kg/m³)</i>								
Volume	0	500	1000	1500	2000	2500	3000	3500
x1000 gal	Amount of salt required (pounds)							
4	117	100	83	67	50	33	17	0
6	175	150	125	100	75	50	25	0
8	234	200	167	133	100	67	33	0
10	292	250	209	167	125	83	42	0
12	350	300	250	200	150	100	50	0
14	409	350	292	234	175	117	58	0
16	467	400	334	267	200	133	67	0
18	525	450	375	300	225	150	75	0
20	584	500	417	334	250	167	83	0
22	642	550	459	367	275	183	92	0
24	701	600	500	400	300	200	100	0
26	759	651	542	434	325	217	108	0
28	817	701	584	467	350	234	117	0
30	876	751	626	500	375	250	125	0
32	934	801	667	534	400	267	133	0
34	992	851	709	567	425	284	142	0
36	1051	901	751	600	450	300	150	0
38	1109	951	762	634	475	317	158	0
40	1168	1001	834	667	500	334	167	0
42	1226	1051	876	701	525	350	175	0
44	1284	1101	917	734	550	367	183	0
46	1343	1151	959	767	575	384	192	0
48	1401	1201	1001	801	600	400	200	0
50	1460	1251	1043	834	626	417	209	0

PROCESS FOR ADDING SALT

1. Prepare the required amount of salt.
2. Switch off the cell.
3. Locate the deepest end of the pool.
4. Empty the salt required at this point (the deepest end of the pool).
5. Start the filtration pump continuously to circulate the water and dissolve the salt.

USE OF CONTROL PANEL

OVERVIEW OF CONTROL PANEL

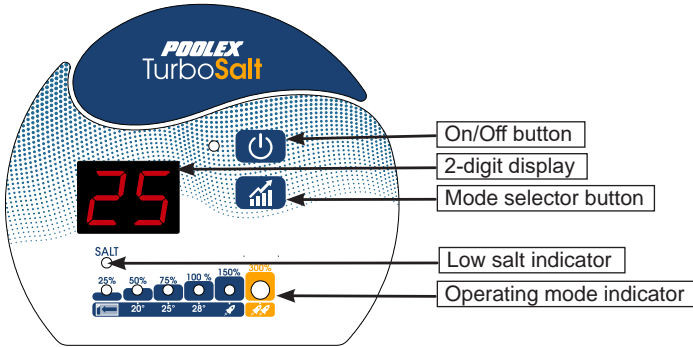

ZEN



On/Off button:

Turns the chlorinator on or off.
On, the LED is green. When off, the LED is red.



Low salt indicator:

Let's you know if salt level is correct.
If the level is good, the LED is green. Otherwise the LED is red. In this case, do a test and add or remove salt (see "Required salt levels", page 32).



2-digit display:

Visually displays different information:

- Chlorinator status: OFF when switched off
- When the chlorinator is on, displays the water temperature by default to make adjustment easier
- Mode selected, changes with each press of the mode switch button:

CO: Covered Pool mode	P8: Comfort mode
P4: Spring mode	B1: BOOST 1 mode
P6: Summer mode	B2: BOOST 2 mode
	B3: Flow ON mode



The mode switch button

Allows, by successive supports, to change the mode of use by incrementing.

During chlorine production, the green LEDs correspond to the mode selected.

When the daily production is finished or in case of shutdown, the 25% LED is red.

Production in progress, shown here in summer mode

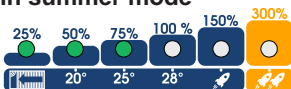

Power status indicator

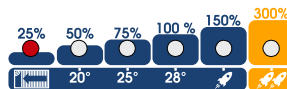

⚠ **Reminder: The electrolyser must be powered 24/7.**

USE OF CONTROL PANEL

SELECTING OPERATING MODES

IMPORTANT: THE CHLORINATOR WILL ONLY FUNCTION WHEN WATER FLOW IS DETECTED, I.E., WHEN THE FILTRATION SYSTEM IS SWITCHED ON. FILTRATION TIME MUST THEREFORE BE SUFFICIENTLY LONG FOR THE SELECTED OPERATING MODE (PREFERABLY ONE TIME SLOT PER DAY DURING PERIODS OF STRONG SUNLIGHT).

Reminder use the following formula to determine the best setting: **Filtration time = (T° water)/2**

1 - Covered Pool Mode (or off-season)

If your pool remains covered for a long enough time, it is necessary to reduce the production time so as not to have an overproduction. An indoor pool is less exposed to organic compounds (bacteria, cells), light and UV. As a result, **hypochlorite builds up to salt more slowly** in an indoor pool.

Overproduction can lead to excessive corrosion of exposed metal parts of your pool.

Select the Indoor Pool (CO) mode when covering your pool for more than 3 days, and off-season when the water temperature is above 10°C but does not exceed 20°C. The electrolyzer will only produce for 2 hours per day.



2 - Spring Mode

At the start of the season, when water temperatures are higher than 20°C, but do not exceed 25°C (i.e. a recommended filtration time of between 10h and 12h), select Spring mode (P4). The chlorinator will produce chlorine for 4 hours per day. Below 10°C, the chlorinator will not function and will display the following error code: E7.



3 - Summer Mode

During the regular season, when water temperatures are higher than 25°C, but do not exceed 28°C (i.e., a recommended filtration time of between 12h and 16h), select Summer mode (P6). The chlorinator will produce chlorine for 6 hours per day.



4 - Comfort Mode

During the peak of the season, or if you heat your pool, when water temperatures are higher than 28°C (i.e., a recommended filtration time of between 16h and 24h), select Comfort mode (P8). The chlorinator will produce chlorine for 8 hours per day.



5 - BOOST 1 mode

Above these temperatures, during periods of hot weather with water temperature exceeding 30°C (i.e., a recommended filtration time of 24h), or following heavy rainfall, it may be necessary to increase hypochlorite production for a limited period of time. Select BOOST 1 mode (B1). The chlorinator will produce chlorine for 12 hours per day.



6 - BOOST 2 mode

During periods of extremely hot weather, with water temperatures exceeding 30°C (i.e., a recommended filtration time of 24h), and/or with intensive use of the pool, it may be necessary to produce even more chlorine for a limited period of time. Select BOOST 2 mode (B2). The chlorinator will produce chlorine for 24h over the course of the day and revert to Comfort Mode (P8) the following day.



7 - Flow ON mode

In this special mode (B3), the chlorinator starts up and continues production as long as the water flow is detected. When this mode is active, check your chlorine levels regularly.

THESE ARE PRESET MODES AND WILL RESTART DAILY AT THEIR SELECTED TIME. DEPENDING ON THE USAGE AND CONDITIONS OF YOUR POOL (VOLUME, EXPOSURE TO PLANT MATERIAL, SUNLIGHT, ETC.), IT MAY BE NECESSARY SWITCH TO A HIGHER OR LOWER MODE. TOREMPERRO BEARUM IDIPSAM CON ESTI TEM ACCULPA RIBUST,

USEFUL TIPS

GENERAL PRINCIPLES

Correct operation of the chlorinator can be easily verified by checking the lights on the control panel. However, if the pool remains cloudy and tests show low levels of residual chlorine, the chlorine produced may have been lost due to high chlorine demand or improper water conditions.

To reduce chlorine demand:

- ✓ Check pH levels (between 7.0 and 7.4)
- ✓ Check stabiliser levels (Cyanuric Acid) are between 20 to 50 ppm
- ✓ Check for the presence of phosphates and nitrates which increase overall chlorine demand : If these tests are positive, a oxidizer shock treatment is recommended.

In general, BOOST modes are not required if the pool is maintained at the correct levels.

LIST OF RECOMMENDED ACTIONS:

- ✓ Read the manual and keep in a safe place for future reference.
- ✓ Adjust chlorine production when temperatures increase or decrease (select the right mode).
- ✓ Increase chlorine production when bathing load increases (see BOOST modes).
- ✓ Use a stabiliser (Cyanuric Acid) at concentrations of 20 to 50 ppm to protect the free chlorine in the pool.
- ✓ Where possible, install the chlorinator out of direct sunlight.
- ✓ Regularly get a water sample tested by a qualified pool professional.
- ✓ Maintain salt concentration levels around 3.5 g/l (3,500 ppm).
- ✓ Regularly test the parameters of the water.
- ✓ Increase production time during sunny hours.

LIST OF PROHIBITED ACTIONS:

- ✗ Do not use fertiliser close to your pool. Fertilisers are an abundant source of Nitrates and Phosphates, resulting in higher chlorine demand and deposits on the chlorinator cell.
- ✗ Never use pure acid to adjust the pH. Deposits of by-products can damage the cell.
- ✗ Do not add any chemicals to the water (including salt) when the chlorinator is switched on (switch it OFF).
- ✗ Do not add chemicals (including salt) directly into the skimmer.
- ✗ Do not allow salinity to fall below 3 g/l (3,000 ppm).
- ✗ Do not connect to filtration.

CLEANING THE CELL

PRINCIPLE

To maintain optimal performance of your chlorinator, the cell should be inspected at least once every 3-4 months: there should be no debris obstructing the flow sensor or between the electrode plates.

The cell has a **self-cleaning** function which uses reverse polarity. In most cases, this self-cleaning function will keep the cell operating efficiently and will prevent formation of scale deposits.

THE CELL SHOULD BE CLEANED ONCE OR TWICE PER SEASON.

DISASSEMBLY

× **Unscrewing the grey mounting nut from the control box will void the warranty.**

1. Shut off the power supply and close any return valves.
2. Unplug the power cable from the transformer.
3. Unscrew the threaded nuts around the PVC connectors which connect the cell to the piping.
4. Remove any residual water (drain into a receptacle and put it back into the pool).
5. Completely remove the union fittings from the cell. DO NOT pull or carry the cell by its power cable.

CLEANING

ALWAYS USE A DESCALING AGENT INTENDED FOR USE IN A SALT CHLORINATOR CELL; FOLLOW THE INSTRUCTIONS AND SAFETY RECOMMENDATIONS OF THE MANUFACTURER.

USING AN INAPPROPRIATE OR HIGHLY CONCENTRATED PRODUCT (PURE ACID) CAN CAUSE VISIBLE AND IRREVERSIBLE DAMAGE TO THE CELL NOT COVERED BY THE WARRANTY AND COULD BE POTENTIALLY DANGEROUS.

WHEN CLEANING THE CELL, ALWAYS WEAR APPROPRIATE PROTECTIVE EQUIPMENT SUCH AS RUBBER GLOVES AND EYE PROTECTION.

ALWAYS WORK IN A WELL-VENTILATED AREA. ACID SPLASHES CAN LEAD TO SERIOUS INJURY AND/OR PROPERTY DAMAGE.

NEVER ADD WATER TO ACID.



1. Follow the steps above to disassemble the cell.
2. Using a **pipe end cap** (e.g. product ref. CL-TSLCAP - not supplied), plug one opening and hold the cell upright, with the end cap at the bottom.
3. Pour the **descaling agent** directly into the cell until it covers all of the deposits.
4. Wait 10 to 20 minutes while periodically agitating the liquid in the cell.
5. Check that all scale deposits have been removed. Perform these steps again if necessary.
6. Once all scale deposits have been removed, rinse and reassemble the cell.

SPECIAL CASE: IF YOUR WATER IS VERY HARD (HIGH CALCIUM CONTENT), SEE "SPECIAL CASE: HARD WATER", PAGE 41.

WINTERIZING

ACTIVE WINTERIZING

When temperatures are low, very little chlorine is required. If actively winterizing your pool, the Covered Pool mode will be sufficient.

However, the chlorinator will not produce chlorine below 10°C and will display an error code (E2); this feature prolongs the service life of the cell.

If water temperature continues to decrease until freezing, the cell and plumbing of your pool will be damaged by the freezing water.

Before first frost, as a precautionary measure, disconnect the cell (following the steps above) by closing the bypass to isolate the circuit. Store your cell in a dry place.

If a bypass is not in place, replace the cell with the winterizing tube (ref CL-TSLTUBE - not supplied). Store your cell in a dry place.



PASSIVE WINTERIZING

In areas subject to periods of prolonged or extreme cold, before first frost, ensure that all water has been removed from the pump, filter, as well as the water supply and return lines.

As a precautionary measure, disconnect the cell (following "Disassembly", page 38) by closing the bypass to isolate the circuit and store your cell in a dry place.

If a bypass is not in place, replace the cell with the winterizing tube (product ref CL-TSLTUBE - provided). Store your cell in a dry place.

RESTARTING IN SPRING

When operating pool equipment for the first time after long periods of inactivity, do not switch on the chlorinator until the water has been balanced, in particular pH and salt concentration, and optimal levels have been reached (namely, pH between 7.0 and 7.4 and salt concentration of 3.5 g/l).

This is also a good time to test the other parameters mentioned at the beginning of this user guide.

WARNING: IF THE WATER HAS TURNED GREEN AFTER WINTERIZING YOUR POOL, THE CHLORINATOR ALONE WILL NOT BE SUFFICIENT TO CLEAR UP GREEN WATER. INTERMITTENT USE OF CHLORINE TABLETS MAY BE NECESSARY. DO NOT PUT THE CHLORINE TABLETS DIRECTLY INTO THE SKIMMER; USE A FLOATING DISPENSER. SWITCH OFF THE CHLORINATOR BEFOREHAND TO PREVENT DAMAGE TO THE CELL.

TROUBLESHOOTING



WARNING: IF THE WATER HAS TURNED GREEN AFTER WINTERIZING YOUR POOL, OR DURING PERIODS OF EXTREMELY HIGH TEMPERATURES, THE CHLORINATOR ALONE WILL NOT BE SUFFICIENT TO CLEAR UP GREEN WATER. INTERMITTENT USE OF CHLORINE TABLETS MAY BE NECESSARY. DO NOT PUT THE CHLORINE TABLETS DIRECTLY INTO THE SKIMMER; USE A FLOATING DISPENSER.

IF YOU NEED TO USE A CHLORINE SHOCK TREATMENT, SWITCH OFF THE CHLORINATOR BEFOREHAND TO PREVENT DAMAGE TO THE CELL.

PERFORMING SYSTEM CHECKS

Even though we take every necessary precaution when manufacturing the chlorinator, breakdowns are still possible.

IN THE EVENT OF A DEFECT AND/OR MALFUNCTION, ELECTRICAL POWER MUST BE SWITCHED OFF AND NO ATTEMPTS TO REPAIR THE FAULT SHOULD BE MADE.

REPAIRS MUST BE CARRIED OUT BY AN AUTHORISED TECHNICIAN USING ORIGINAL SPARE PARTS.

Not complying with the aforementioned clauses can negatively impact the safe operation of the chlorinator.

However, other factors inherent to the electrolyzer may impact the treatment performance. If there is a problem with the quality of your water (water starting to green), please check the following points:

- ✓ Check that it is plugged in
- ✓ Check that the power supply is still present and that the differential protection is not tripped (or the circuit breaker upstream). If in doubt, call a professional.
- ✓ Check that the parameters of the water are correct (salinity, stabiliser level, pH and if necessary hardness and alkalinity)
- ✓ Check that the water flow is between 2m³/h and 10m³/h
- ✓ Check that the filtration time is sufficiently long: **Filtration time = (T° water)/2**

In order to obtain an optimal treatment, we advise you to **select the mode according to the temperature of your water**, and to use the two modes BOOST if the conditions impose it (high temperature or high attendance). Depending on your use and your pool (volume, exposure to vegetation, sun, etc.), a change of mode up or down may be necessary. These modes are preset modes: they restart each day at the time the mode was selected.

IF YOU SPLIT YOUR DAILY FILTRATION TIME INTO MULTIPLE SEQUENCES, MAKE SURE THAT THE SIMULTANEOUS SEQUENCE TO TREATMENT IS LONG ENOUGH TO ENCOMPASS THE ENTIRE TREATMENT TIME.

In addition, depending on the mode, the minimum daily filtration time must be respected:

TROUBLESHOOTING

Mode	Covered <i>C0</i>	Spring <i>P4</i>	Summer <i>Pb</i>	Comfort <i>PB</i>	BOOST 1 <i>B1</i>	BOOST 2 <i>B2</i>
T° water	10°C ≤ t° < 20°C or covered pool	20°C ≤ t° < 25°C	25°C ≤ t° < 28°C	t° ≥ 28°C	t° ≥ 28°C or intensive use	t° ≥ 30°C or intensive use
Treatment time	2h	4h	6h	8h	12h	24h
Filtration time	5h to 10h	10h to 12h	12h to 16h	16h to 24h	24h	24h

If despite this you encounter problems then, maybe your electrolyzer is down. Also, the electrolyzer has a self-diagnostic system to indicate a possible problem via error codes.

SPECIAL CASE: HARD WATER

In areas where the water is very hard (= high calcium content) and in pools with an unbalanced chemical composition, the cell may require specific cleaning. Indeed, electrolysis creates chlorine (hypochlorite) from salt but also naturally generates the formation of a mineral deposit on titanium electrodes in the cell. The self-cleaning function by polarity inversion helps to prevent the formation of these deposits and scaling. If the water is very hard and the TH is high, the formation of deposits is inevitable and these must be removed.

REPLACING THE CELL

Once the titanium plates inside the chlorinator cell have reached the end of their service life (after around 10,000h), they can be replaced. To guarantee quality and value, only use original spare parts. If necessary, bypass tubes can be used to allow water to continue circulating in the pipework once the cell has been removed. See chapter on winterizing (Winterizing tube product ref. CL-TSLTUBE).

LIST OF ERROR CODES AND THEIR SOLUTIONS

E2 : Water temperature is outside of normal operating range

Comment : The normal operating range for water temperature is between 10°C and 45°C.

Solution : Check the water temperature

- If the water temperature of your pool is below 10°C, consider winterizing your device.
- If the water temperature of your pool is above 45°C, switch off the chlorinator and wait for the temperature to drop to the normal operating range.
- If the actual temperature of the water is within the normal operating range, check if error code E3 or E7 is also displayed (see section on errors E3 and E7 below).

TROUBLESHOOTING

E3 : Water flow not detected

Comments : The normal operating range for flow rate is between 2 m³/h and 10 m³/h.

If the daily filtration time is divided into several ranges and the range times are shorter than the processing time then this error may temporarily appear during breaks between ranges until the processing time is completed on the subsequent range.

Solutions : Check the following:

- The filtration time is sufficiently long to encompass the entire length of the treatment.
- The bypass is providing enough water to the cell and the valves are correctly set.
- The filter is not clogged/obstructed (clean if necessary).
- The flow rate of the rate is sufficient.
- The presence of debris/scale deposits in the cell may obstruct the flow sensor (clean if necessary following "Cleaning the cell", page 38).

If all of the steps above have been followed and the error persists, contact customer service for a replacement flow sensor.

E5 : Salt concentration is too low

Comment : The normal operating range for salt concentration 2,700 to 4,500 ppm.

Solutions : Test the salt concentration of the water.

If necessary, add salt until reaching 3 g/l; ensure the chlorinator is switched off until the salt has fully dissolved (see "Adding salt", page 32).

Once the correct level has been reached, the chlorinator should operate normally again.

E7 : Fatal error in temperature sensor

Solution : Contact customer support for a replacement temperature sensor.

E8 : Transformer output voltage error

Solution : Contact customer support for a replacement transformer.

E9 : Output current error

Solution : Contact customer support for a replacement transformer or cell.

EA : Cell error



Solutions : Test salt concentration and correct if necessary.

If the error persists, contact customer support for a replacement cell.

EC : Electronics error

Solutions : Unplug the transformer, wait one minute, then plug back in.

If the error persists, contact customer support for replacement circuit boards.

If the audible alarm bothers you, you can silence it by pressing the on/off  and power level  buttons for 5 seconds.

WARRANTY

The Turbo-Salt salt chlorinator is guaranteed free of any material or manufacturing defects, for normal use and non-commercial applications, for a period of **five (5) years** or 10,000h, subject to the following conditions:

- Proof of purchase is required.
- This limited warranty applies to the case and generator cell.
- This limited warranty extends exclusively to the original purchaser of the chlorinator system and is non-transferable.
- The Turbo-Salt salt chlorinator is intended for use in private pools and any commercial use voids this warranty.
- Three (3) years or 7000h limited warranty for the case and generator.

This warranty does not apply to the following situations:

- Faults or damage arising from installation, use or repairs which do not comply with the safety instructions.
- Faults or damage arising from improper use of the chlorinator pursuant to the manufacturer's recommendations, as set out in this User Guide.
- Faults or damage arising from an improper chemical environment in the pool.
- Faults arising from failure to maintain the chemical properties of the pool at the appropriate levels, in accordance with the manufacturer's recommendations, as set out in this User Guide.
- Faults or damage arising from sabotage, accidents, electrical surges, abuse, negligence, unauthorised or unqualified repairs, alterations to the product, or damage due to fire, floods or frost, acts of God or force majeure.
- Faults or damage arising from unintended use of the device.
- Damage arising from negligence, accidents or force majeure.
- Faults or damages arising from the use of unauthorised accessories.
- Damage or deterioration of concrete, natural stone, wood or synthetic surfaces nearby the pool.

Legal disclaimer: this limited warranty constitutes the entire warranty.

No other guarantees apply, explicit or implicit. This limited warranty grants specific legal rights which may vary by jurisdiction. Under no circumstances shall we be liable for consequential damage(s), special or indirect, regardless of nature, including but not limited to physical injury, property damage, or damage or loss of equipment. The agent / installer shall not be liable for any costs arising from installation or maintenance.

Repairs undertaken during the warranty period must be approved before being carried out by a certified technician. This warranty is voided in the event of repairs to the device made by individuals which have not been authorised by Poolstar.

The parts under warranty shall be replaced or repaired at the discretion of Poolstar. Faulty parts must be returned to us during the warranty period in order to be covered by the warranty. The warranty does not cover unauthorised replacements or labour costs. Delivery costs for returning the faulty part are not covered by the warranty.

Madame, Monsieur,

**Merci de consacrer quelques minutes à remplir un bon de garantie
que vous trouverez sur notre site Internet :**

<http://assistance.poolstar.fr/>

Nous vous remercions de votre confiance
et vous souhaitons une excellente baignade.

Vos coordonnées pourront être traitées conformément à la Loi Informatique et Liberté
du 6 janvier 1978 et ne seront divulguées à quiconque.

Do you have

**A question? A problem? Or if you simply want to register your warranty,
head over to our website:**

<http://support.poolex.fr/>

**Thank you for your trust and support.
Happy bathing!**

Your personal information is processed in accordance with the French Data Protection
Act of 06 January 1978 and will not be shared with 3rd parties.

Estimado(a) cliente,

**¿Tiene preguntas? ¿Hay algún problema? O simplemente registre su
garantía, nos encontrará en nuestra página web:**

<http://support.poolex.fr/>

**Le agradecemos la confianza
y esperamos que disfrute del baño.**

Sus datos podrán ser tratados de acuerdo con la Ley de Protección de Datos del 6 de
enero de 1978 y no serán revelados a nadie

POOLEX



Assistance technique - Technical support -
Asistencia técnica - Assistenza tecnica -
Technische unterstützung - Technische bijstand

www.assistance.poolstar.fr
contact@poolstar.fr

Poollex is a brand of the group :

