

POOLEX

Silent Max

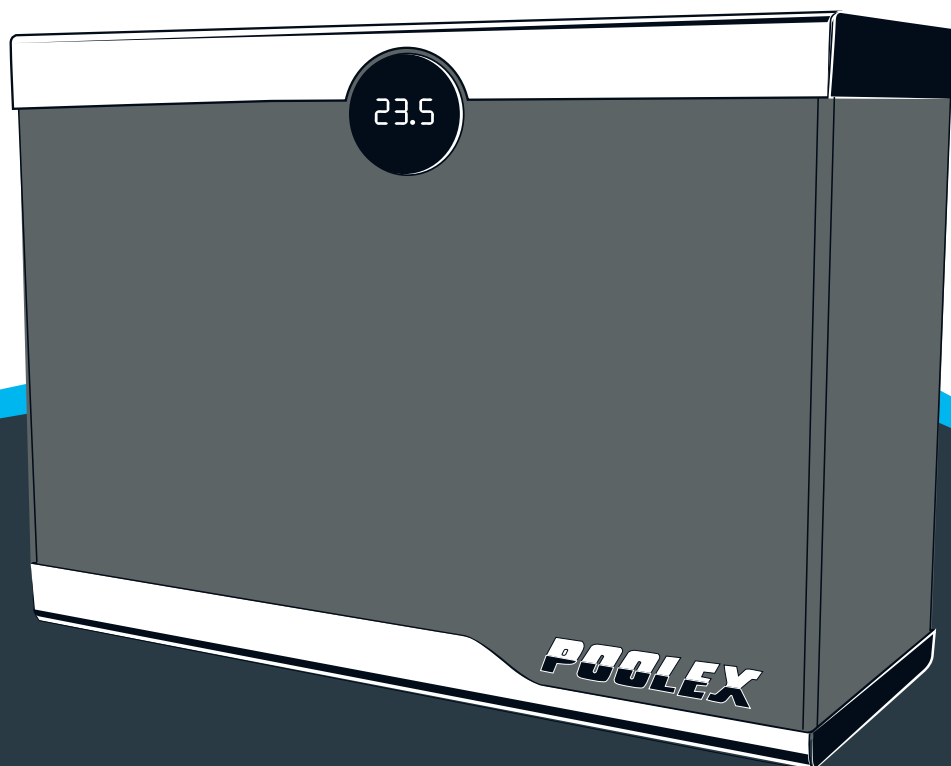

INSTALLATION AND USER MANUAL
for your heat pump

Warning



This heat pump contains a flammable refrigerant R32.

Any intervention on the refrigerant circuit is prohibited without a valid authorization.

Before working on the refrigerant circuit, the following precautions are necessary for safe work.

1. Work procedure

The work must be carried out according to a controlled procedure, in order to minimize the risk of presence of flammable gases or vapors during the execution of the works.

2. General work area

All persons in the area must be informed of the nature of the work in progress. Avoid working in a confined area. The area around the work area should be divided, secured and special attention should be paid to nearby sources of flame or heat.

3. Verification of the presence of refrigerant

The area should be checked with a suitable refrigerant detector before and during work to ensure that there is no potentially flammable gas. Make sure that the leak detection equipment used is suitable for flammable refrigerants, ie it does not produce sparks, is properly sealed or has internal safety.

4. Presence of fire extinguisher

If hot work is to be performed on the refrigeration equipment or any associated part, appropriate fire extinguishing equipment must be available. Install a dry powder or CO2 fire extinguisher near the work area.

5. No source of flame, heat or spark

It is totally forbidden to use a source of heat, flame or spark in the direct vicinity of one or more parts or pipes containing or having contained a flammable refrigerant. All sources of ignition, including smoking, must be sufficiently far from the place of installation, repair, removal and disposal, during which time a flammable refrigerant may be released into the surrounding area. Before starting work, the environment of the equipment should be checked to ensure that there is no risk of flammability. «No smoking» signs must be posted.

6. Ventilated area

Make sure the area is in the open air or is properly ventilated before working on the system or performing hot work. Some ventilation must be maintained during the duration of the work.

7. Controls of refrigeration equipment

When electrical components are replaced, they must be suitable for the intended purpose and the appropriate specifications. Only the parts of the manufacturer can be used. If in doubt, consult the technical service of the manufacturer.

The following controls should be applied to installations using flammable refrigerants:

- *The size of the load is in accordance with the size of the room in which the rooms containing the refrigerant are installed;*
- *Ventilation and air vents work properly and are not obstructed;*
- *If an indirect refrigeration circuit is used, the secondary circuit must also be checked.*
- *The marking on the equipment remains visible and legible. Illegible marks and signs must be corrected;*
- *Refrigeration pipes or components are installed in a position where they are unlikely to be exposed to a substance that could corrode components containing refrigerant*

8. Verification of electrical appliances

Repair and maintenance of electrical components must include initial safety checks and component inspection procedures. If there is a defect that could compromise safety, no power supply should be connected to the circuit until the problem is resolved.

Initial security checks must include:

- *That the capacitors are discharged: this must be done in a safe way to avoid the possibility of sparks;*
- *No electrical components or wiring are exposed during loading, recovery or purging of the refrigerant gas system;*
- *There is continuity of grounding.*

Thank you

Dear Customer,

Thank you for your purchase and for your confidence in our products.

These are the result of many years of research in the field of design and production of heat pumps for swimming pools. Our aim is to provide you with an exceptional high performance quality product.

We have produced this manual with the utmost care so that you get maximum benefit from your Poolex heat pump.

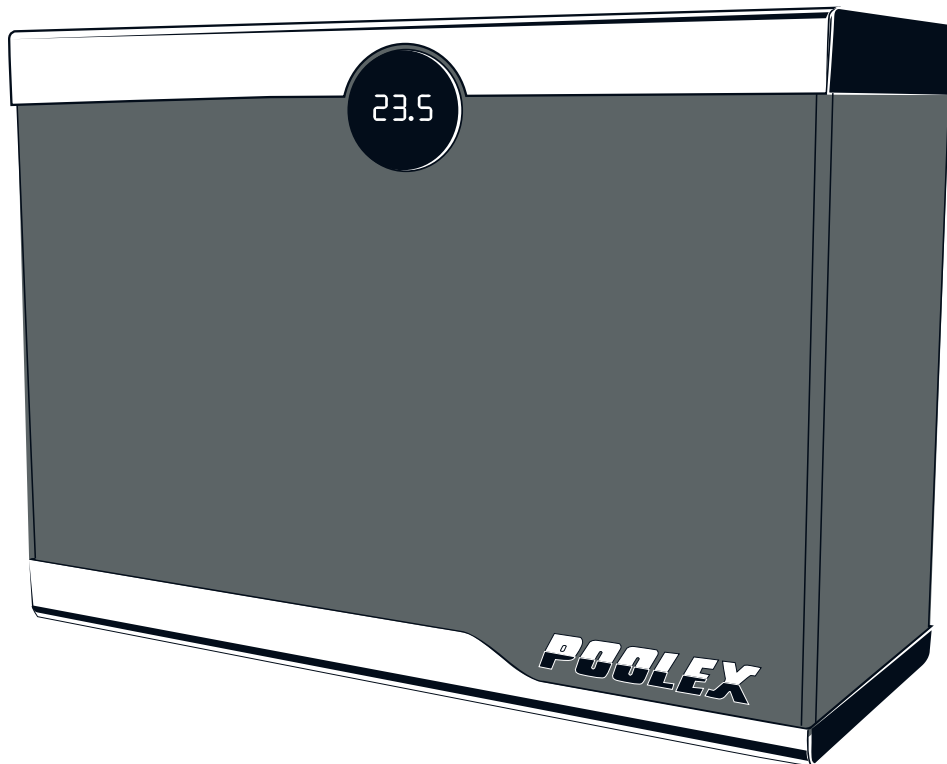



PLEASE READ CAREFULLY



**These installation instructions are an integral part of the product.
They must be given to the installer and retained by the user.
If the manual is lost, please consult the website:**

www.poolex.fr

The instructions and recommendations contained in this manual should be read carefully and understood since they provide valuable information concerning the heat pump's safe handling and operation. **Keep this manual in an accessible place for easy future reference.**

Installation must be carried out by a qualified professional person in accordance with current regulations and the manufacturer's instructions. An installation error may cause physical injury to persons or animals as well as mechanical damage for which the manufacturer can under no circumstances be held responsible.

After unpacking the heat pump, please check the contents in order to report any damage.

Prior to connecting the heat pump, ensure that the information provided in this manual is compatible with the actual installation conditions and does not exceed the maximum limits authorised for this particular product.

In the event of a defect and/or malfunction of the heat pump, the electricity supply must be disconnected and no attempt made to repair the fault.

Repairs must be undertaken only by an authorised technical service organisation using original replacement parts. Failure to comply with the above-mentioned clauses may have an adverse effect on the heat pump's safe operation.

To guarantee the heat pump's efficiency and satisfactory operation, it is important to ensure its regular maintenance in accordance with the instructions provided.

If the heat pump is sold or transferred, always make sure that all technical documentation is transmitted with the equipment to the new owner.

This heat pump is designed solely for heating a swimming pool. Any other use must be considered as being inappropriate, incorrect or even hazardous.

Any contractual or non-contractual liability of the manufacturer/distributor shall be deemed null and void for damage caused by installation or operational errors, or due to non-compliance with the instructions provided in this manual or with current installation norms applicable to the equipment covered by this document.

Contents

1.	General	6
1.1	General Terms of Delivery	6
1.2	Safety instructions	6
1.3	Water treatment	7
2.	Description	8
2.1	Package contents	8
2.2	General characteristics	8
2.3	Technical specifications	9
2.4	Unit dimensions	10
2.5	Exploded view	11
3.	Installation	12
3.1	Pre-requirements	12
3.2	Location	12
3.3	Installation layout	13
3.4	Connecting the condensation draining kit	13
3.5	Installing the unit on noise-damping supports	13
3.6	Hydraulic connection	14
3.7	Electrical installation	16
3.8	Electrical connection	17
4.	Use	18
4.1	Wired remote control	18
4.2	Start-up and locking	19
4.3	Operating mode selector	19
4.4	Setting the set temperature	20
4.5	Clock Setting	20
4.6	On / Off synchronization adjustment	21
4.7	Activation / deactivation of On / Off groups	21
4.8	Download & Installation of the Smart Life Application	22
4.9	Setting up the application	23
4.10	Pairing the heat pump	25
4.11	Controlling	26
5.	Operation	28
5.1	Operation	28
5.2	Servo-control of circulating pump	28
5.3	Using the pressure gauge	29
5.4	Antifreeze protection	29
6.	Maintenance and servicing	30
6.1	Maintenance and servicing	30
6.2	Winter storage	30
7.	Repairs	31
7.1	Breakdowns and faults	31
7.2	Advanced settings for status values	31
7.3	List of faults	32
8.	Warranty	34
8.1	General warranty conditions	34
9.	Appendices	35
9.1	Wiring diagrams	35
9.2	List of default parameters	36
9.3	System parameter query	38

1. General

1.1 General Terms of Delivery

All equipment, even if shipped 'free of carriage and packing', is dispatched at the consignee's own risk.

The person responsible for receiving the equipment must carry out a visual inspection to identify any damage to the heat pump during transport (refrigerant system, body panels, electrical control box, frame). He/she must note down on the carrier's delivery note any remarks concerning damage caused during transport and confirm them to the carrier by registered letter within 48 hours.

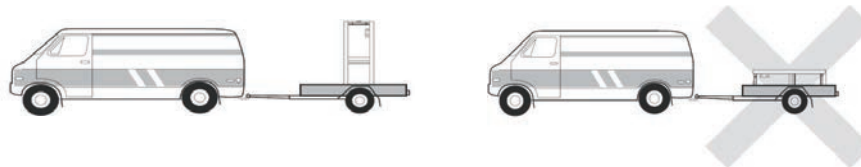

The equipment must always be stored and transported vertically on a pallet and in its original packaging. If it is stored or transported horizontally, wait at least 24 hours before switching it on.

1.2 Safety instructions



WARNING: Please read carefully the safety instructions before using the equipment. The following instructions are essential for safety so please strictly comply with them.

During installation and servicing

Only a qualified person may undertake installation, start-up, servicing and repairs, in compliance with current standards.

Before operating or undertaking any work on the equipment (installation, commissioning, usage, servicing), the person responsible must be aware of all the instructions in the heat pump's installation manual as well as the technical specifications.

Under no circumstances install the equipment close to a source of heat, combustible materials or a building's air intake.

If installation is not in a location with restricted access, a heat pump protective grille must be fitted.

To avoid severe burns, do not walk on pipework during installation, repairs or maintenance.

To avoid severe burns, prior to any work on the refrigerant system, turn off the heat pump and wait several minutes before placing temperature and pressure sensors.

Check the refrigerant level when servicing the heat pump.

Check that the high and low pressure switches are correctly connected to the refrigerant system and that they turn off the electrical circuit if tripped during the equipment's annual leakage inspection.

Check that there is no trace of corrosion or oil stains around the refrigerant components.

1. General

During use

To avoid serious injuries, never touch the fan when it is operating.

Keep the heat pump out of the reach of children to avoid serious injuries caused by the heat exchanger's blades.

Never start the equipment if there is no water in the pool or if the circulating pump is stopped.

Check the water flow rate every month and clean the filter if necessary.

During cleaning

Switch off the equipment's electricity supply.

Close the water inlet and outlet valves.

Do not insert anything into the air or water intakes or outlets.

Do not rinse the equipment with water.

During repairs

Carry out work on the refrigerant system in accordance with current safety regulations.

Brazing should be performed by a qualified welder.

When replacing a defective refrigerant component, use only parts certified by our technical department.

When replacing pipework, only copper pipes conforming to Standard NF EN12735-1 may be used for repairs.

When pressure-testing to detect leaks:

To avoid the risks of fire or explosion, never use oxygen or dry air.

Use dehydrated nitrogen or a mixture of nitrogen and refrigerant.

The low and high side test pressure must not exceed 42 bar.

1.3 Water treatment

Poolex heat pumps for swimming pools can be used with all types of water treatment systems.

Nevertheless, it is essential that the treatment system (chlorine, pH, bromine and/or salt chlorinator metering pumps) is installed after the heat pump in the hydraulic circuit.

To avoid any deterioration to the heat pump, the water's pH must be maintained between 6.9 and 8.0.

2. Description

2.1 Package contents

- ✓ Heat pump Poolex Silent Max
- ✓ 2 hydraulic inlet/outlet connectors (50mm diameter)
- ✓ Extension cable for control panel
- ✓ This installation and user manual
- ✓ Condensation draining kit
- ✓ Winter storage cover
- ✓ 4 anti-vibration pads (fastenings not supplied)

2.2 General characteristics

A Poolex heat pump has the following features:

- ◆ High performance with up to 80% energy savings compared to a conventional heating system.
- ◆ Clean, efficient and environmentally friendly R32 refrigerant.
- ◆ Reliable high output leading brand compressor.
- ◆ Wide hydrophilic aluminium evaporator for use at low temperatures.
- ◆ User-friendly intuitive control panel.
- ◆ CE certification.
- ◆ Designed to be silent.
- ◆ Dual antifreeze system to avoid frost damage:
 - Revolutionary exchanger with patented antifreeze system.
 - A smart monitoring system to preserve the pipework and liner without emptying the pool in winter.

2. Description

2.3 Technical specifications

Test conditions	Poollex Silent Max			
	80	125	150	
Air ⁽¹⁾ 26°C Water ⁽²⁾ 26°C INVERTER MODE	Heating power (kW)	2.46~7.45	2.2~12.3	2.4~15.0
	Consumption (kW)	1.3-0.18	1.93-0.22	2.35-0.25
	COP (Coeff. of performance)	13.5-6.1	16.5-6.4	16.6-6.5
Air ⁽¹⁾ 26°C Water ⁽²⁾ 26°C SILENCE MODE	Heating power (kW)	4.40~2.46	6.4~2.2	8.6~2.4
	Consumption (kW)	0.32-0.23	0.39-0.26	0.52-0.23
	COP (Coeff. of performance)	13.5-10.4	16.5-10.2	16.6-10.5
Air ⁽¹⁾ 15°C Water ⁽²⁾ 26°C INVERTER MODE	Heating power (kW)	6.0-1.4	9.05-1.6	11.2-1.9
	Consumption (kW)	1.3-0.18	1.93-0.22	2.35-0.25
	COP (Coeff. of performance)	7.5-4.6	7.2-4.7	7.6-4.8
Air ⁽¹⁾ 15°C Water ⁽²⁾ 26°C SILENCE MODE	Heating power (kW)	3.2-1.35	4.8-1.6	6.5-1.9
	Consumption (kW)	0.43-0.21	0.67-0.25	0.86-0.29
	COP (Coeff. of performance)	7.5-6.5	7.2-6.5	7.6-6.6
Air ⁽¹⁾ 15°C Water ⁽²⁾ 26°C FIX MODE	Heating power (kW)	6,0	9.05	11,2
	Consumption (kW)	1,30	1,93	2,35
	COP (Coeff. of performance)	4.6	4.7	4.8
Air ⁽¹⁾ 35°C Water ⁽²⁾ 27°C	Cooling capacity (kW)	3.4-1.1	4.8-1.8	5.5-2.1
	Consumption (kW)	0.81-0.28	1.3-0.32	1.57-0.40
	Avg. EER (Energy Efficiency Ratio)	3,86	3,5	3,4
Maximum power (kW)	1.7	2.6	3.2	
Maximum current (A)	8	13	14	
Electricity supply	220~240V / 50Hz			
Protection	IPX4			
Heating temperature range	15°C~40°C			
Cooling temperature range	8°C~28°C			
Operating temperature range	-7°C~43°C			
Unit dimensions L x W x H (mm)	870x355x647	975x376x647	1040x406x747	
Unit weight (kg)	46	56	72.5	
Sound pressure level at 1 m (dBA) ⁽³⁾	<37~<49	<38~50	<39~51	
Sound pressure level at 10 m (dBA) ⁽³⁾	<19~<28	<19~<29	<20~<30	
Hydraulic connection (mm)	PVC 50mm			
Heat exchanger	PVC tank and Titanium coil			
water flow rate (m ³ /h)	2~4	4~6	5~7	
Compressor	Toshiba			
Compressor type	Helmetic Rotary DC inverter compressor			
Refrigerant	R32			
Refrigerant volume (kg)	0.35	0.65	0.80	
Load loss (mCE)	1.1	1.1	1.1	
Telecommande	LCD control screen			
Mode	Eco Booster & Eco Silence (Inverter) / Heating / Cooling			

The technical specifications of our heat pumps are provided for information purposes only. We reserve the right to make changes without prior notice.

¹ Ambient air temperature

² Initial water temperature

³ Noise at 1 m, at 4 m and at 10 m in accordance with Directives EN ISO 3741 and EN ISO 354

⁴ Calculated for an in-ground private swimming pool covered with a bubble cover in France

2. Description

2.4 Unit dimensions

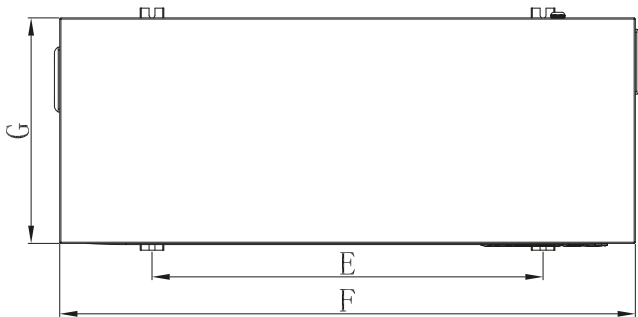
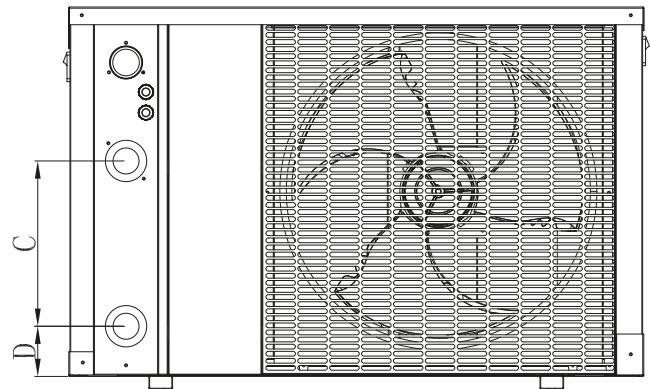
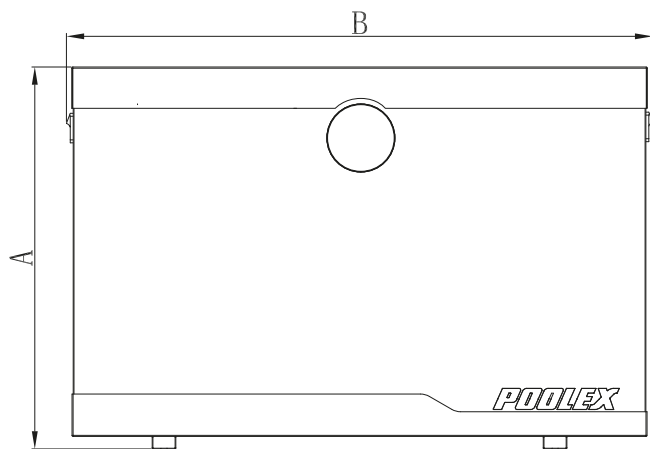

Dimensions in mm

Model	80	125	155
A	647	647	747
B	893	993	1064
C	260	280	367
D	75	85	74
E	582	662	713
F	875	975	1044
G	362	382	412

2. Description

2.5 Exploded view

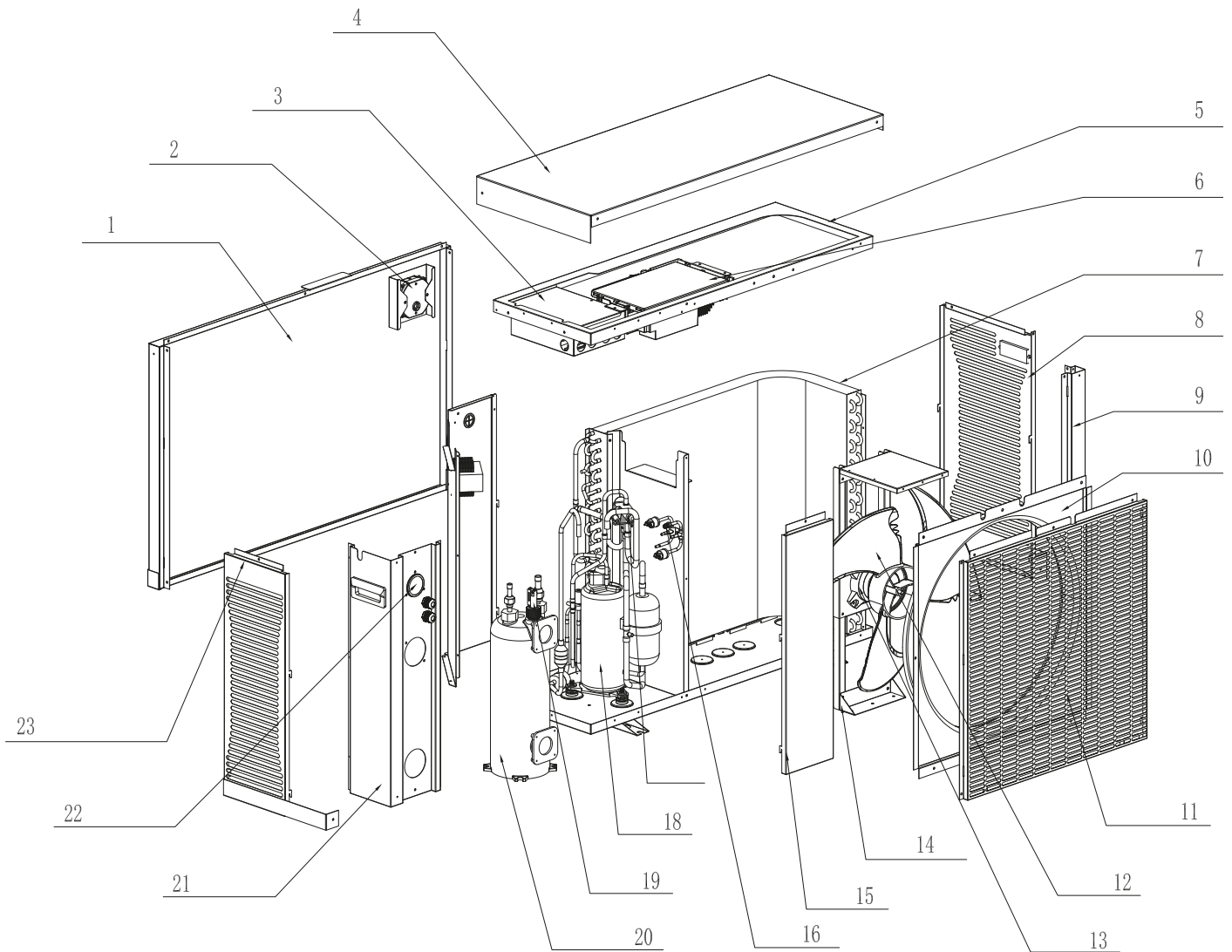

- 1. Front panel
- 2. Control panel
- 3. Electrical box cover
- 4. Top panel
- 5. Support
- 6. Electrical control box
- 7. Evaporator
- 8. Left side grill
- 9. Mounting frame
- 10. Air flux
- 11. Fan protective grille
- 12. Fan blade
- 13. Fan motor
- 14. Fan support
- 15. Back panel
- 16. One way valve
- 17. 4-way valve
- 18. Compressor
- 19. Water Flow Switch
- 20. Heat exchanger
- 21. Right side Panel
- 22. Pressure gauge
- 23. Right side panel

3. Installation



WARNING: Installation must be carried out by a qualified engineer.

This section is provided for information purposes only and must be checked and adapted if necessary according to the actual installation conditions.

3.1 Pre-requirements

Equipment necessary for the installation of your heat pump:

Power supply cable suitable for the unit's power requirements.

A *By-Pass* kit and an assembly of PVC tubing suitable for your installation as well as stripper, PVC adhesive and sandpaper.

A set of wall plugs and expansion screws suitable to attach the unit to your support.

We recommend that you connect the unit to your installation by means of flexible PVC pipes in order to reduce the transmission of vibrations.

Suitable fastening studs may be used to raise the unit.

3.2 Location

Please comply with the following rules concerning the choice of heat pump location.

1. The unit's future location must be easily accessible for convenient operation and maintenance.
2. It must be installed on the ground, fixed ideally on a level concrete floor. Ensure that the floor is sufficiently stable and can support the weight of the unit.
3. A water drainage device must be provided close to the unit in order to protect the area where it is installed.
4. If necessary, the unit may be raised by using suitable mounting pads designed to support its weight.
5. Check that the unit is properly ventilated, that the air outlet is not facing the windows of neighbouring buildings and that the exhaust air cannot return. In addition, provide sufficient space around the unit for servicing and maintenance operations.
6. The unit must not be installed in an area exposed to oil, flammable gases, corrosive products, sulphurous compounds or close to high frequency equipment.
7. To prevent mud splashes, do not install the unit near a road or track.
8. To avoid causing nuisance to neighbours, make sure the unit is installed so that it is positioned towards the area that is least sensitive to noise.
9. Keep the unit as much as possible out of the reach of children.

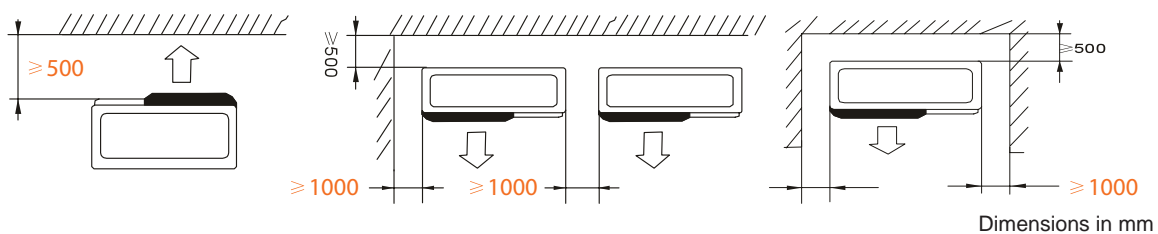

Place nothing less than 0.5m in front of the heat pump.
Leave 1 m of empty space around the sides of the heat pump.
Do not leave any obstacle above or in front of the unit!

3. Installation

3.3 Installation layout

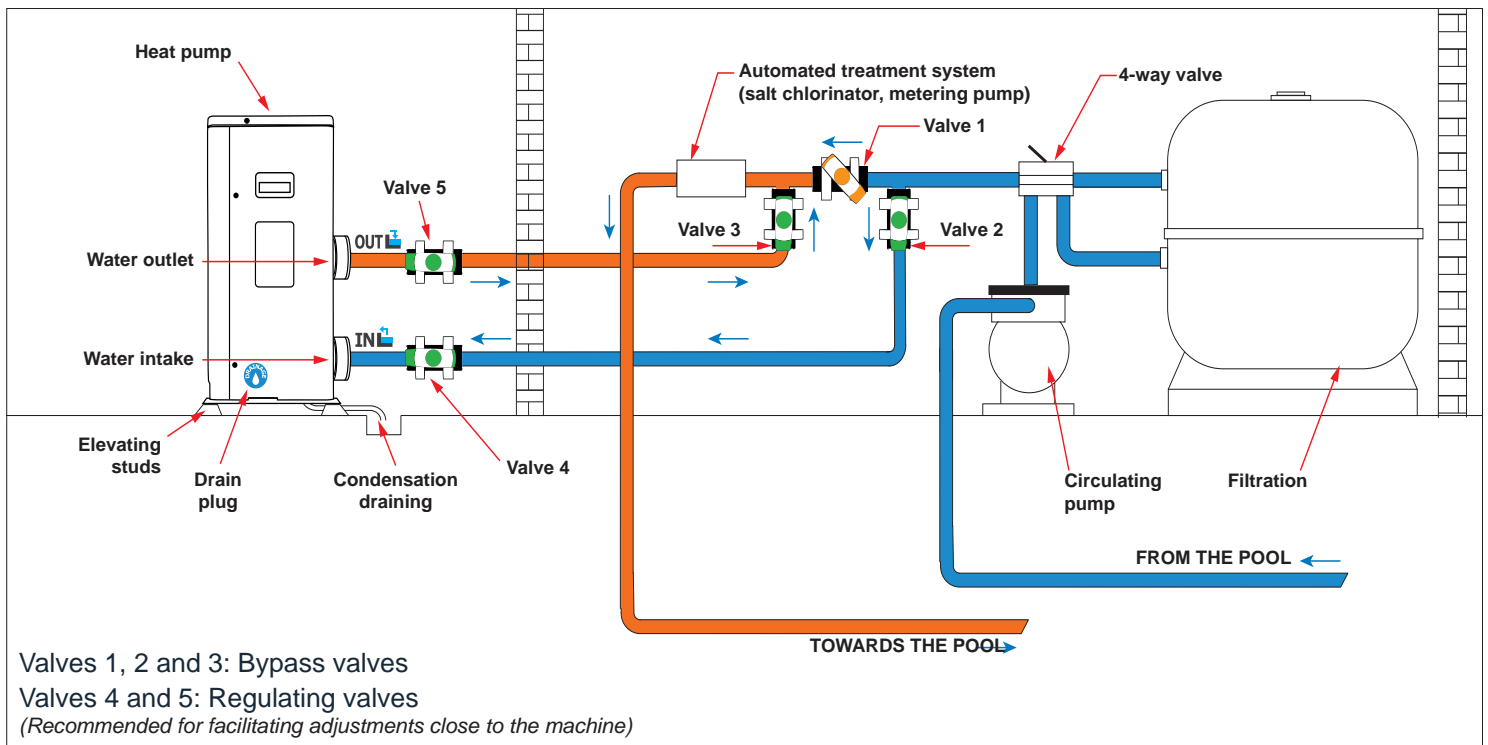

3.4 Connecting the condensation draining kit

While operating, the heat pump is subject to condensation. This will result in a more or less large run-off of water, depending on the degree of humidity. To channel this flow, we recommend that you install the condensation drainage kit.

How do you install the condensation drainage kit?

Install the heat pump, raising it at least 10 cm with solid water-resistant pads, then connect the drainage pipe to the opening located under the pump.

3.5 Installing the unit on noise-damping supports

In order to minimise the noise pollution associated with heat pump vibrations, it can be positioned on vibration absorbing pads.

To do this, you simply have to position a pad between each of the unit's feet and its support, and then fix the heat pump to the support with suitable screws.

3. Installation



WARNING: Installation must be carried out by a qualified engineer.

This section is provided for information purposes only and must be checked and adapted if necessary according to the actual installation conditions.

3.6 Hydraulic connection

By-Pass assembly

The heat pump must be connected to the pool by means of a By-Pass assembly.

A By-Pass is an assembly consisting of 3 valves that regulate the flow circulating in the heat pump. During maintenance operations, the By-Pass permits the heat pump to be isolated from the system without interrupting your installation.

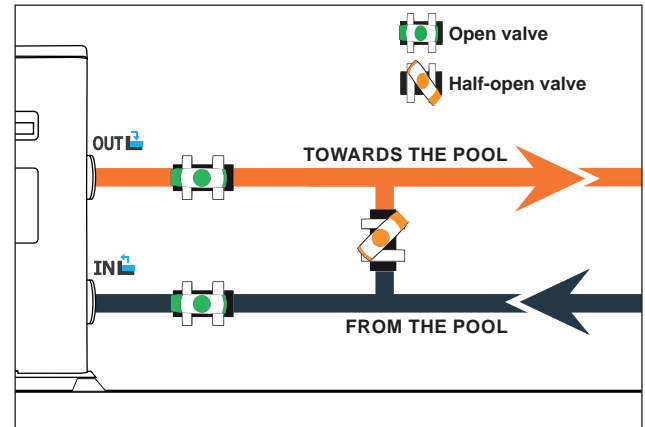

Making a hydraulic connection with the By-Pass kit



WARNING: Do not run water through the hydraulic circuit for 2 hours after applying the adhesive.

Step 1: Take the necessary steps to cut your pipes.

Step 2: Make a straight perpendicular cut through the PVC pipes with a saw.

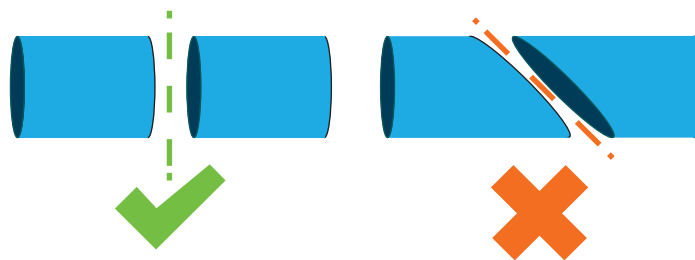

Step 3: Assemble your hydraulic circuit without connecting it in order to check that it perfectly fits your installation, then dismantle the pipes to be connected.

Step 4: Chamfer the ends of the cut pipes with sandpaper.

Step 5: Apply stripper to the ends of the pipes to be connected.

Step 6: Apply the adhesive in the same place.

Step 7: Assemble the pipes.

Step 7: Clean off any adhesive remaining on the PVC.

Step 8: Leave to dry for at least 2 hours before putting the hydraulic circuit into water.

3. Installation

By-Pass assembly for one heat pump

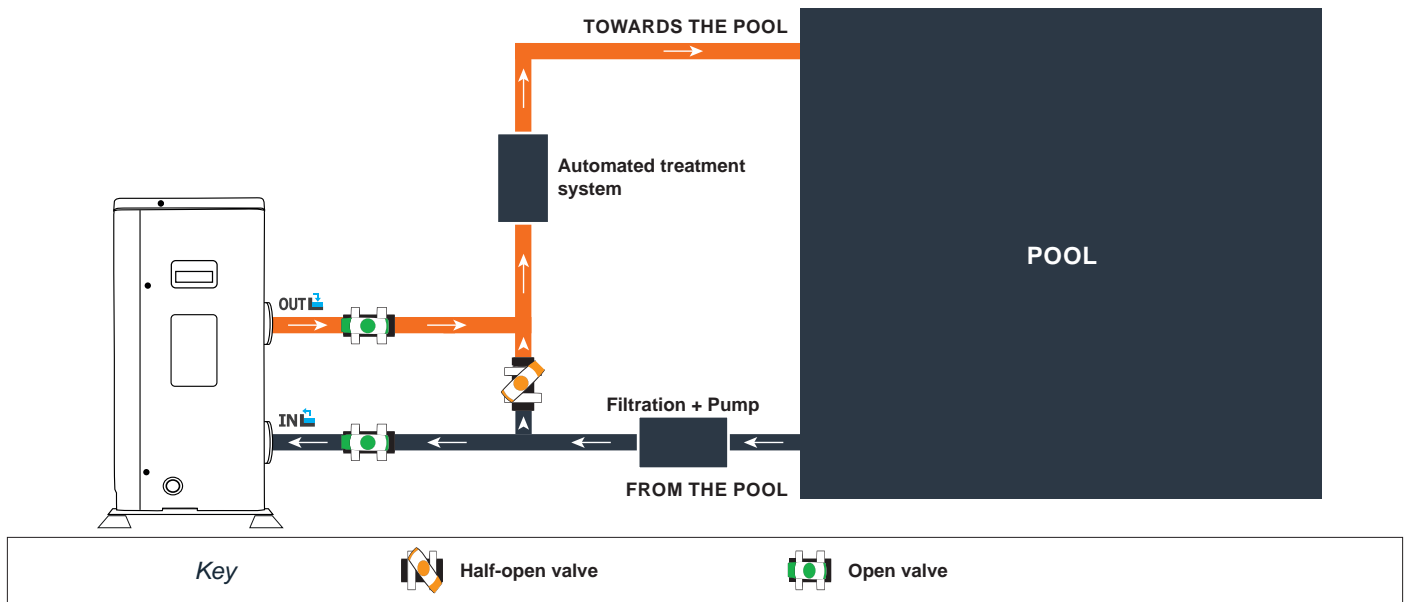

By-Pass assembly for more than one heat pump

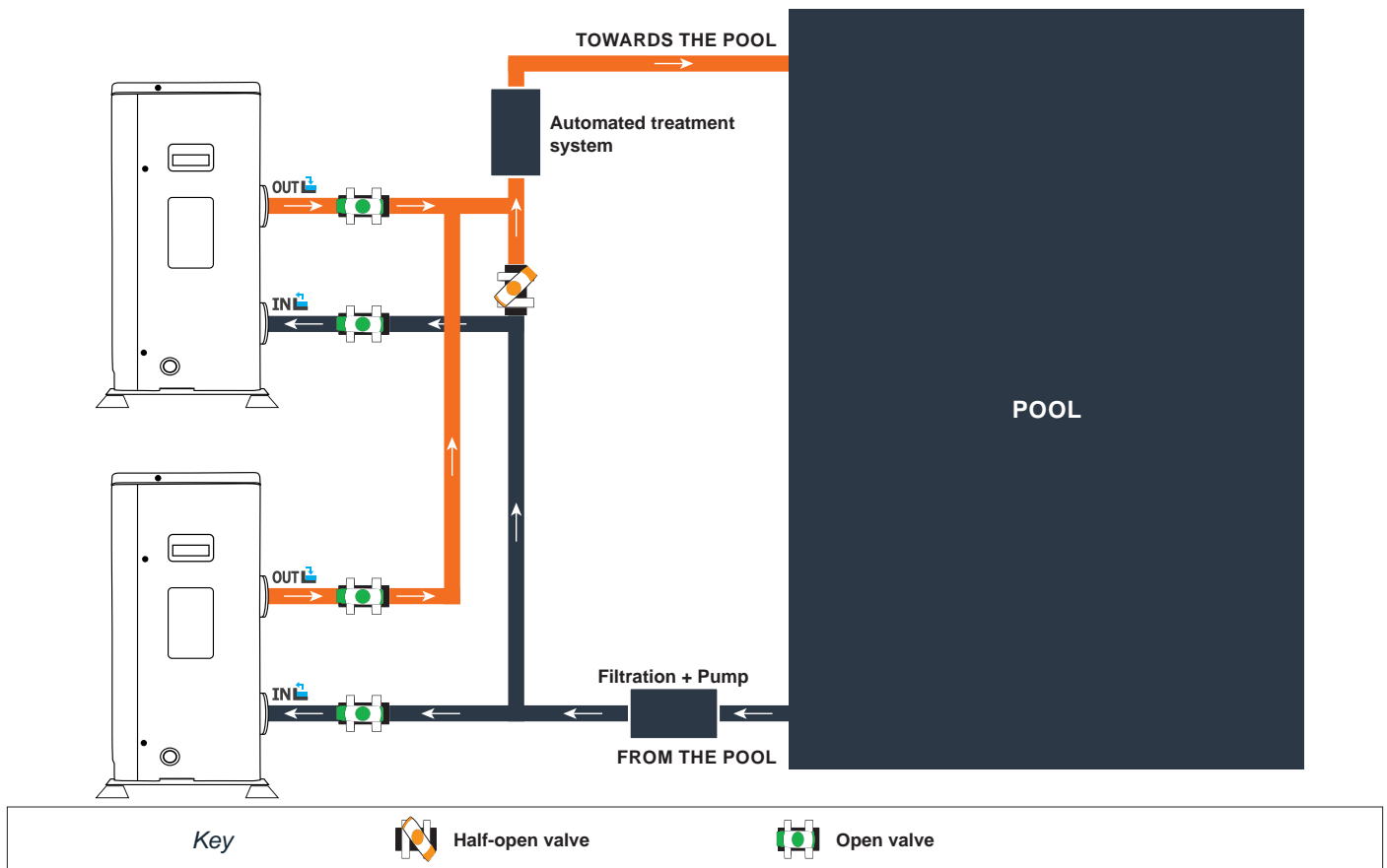

The filter located upstream of the heat pump must be regularly cleared so that the water in the system is clean, thus avoiding the operational problems associated with dirt or clogging in the filter.

3. Installation



WARNING: Installation must be carried out by a qualified engineer.

This section is provided for information purposes only and must be checked and adapted if necessary according to the actual installation conditions.

3.7 Electrical installation

To function safely and maintain the integrity of your electrical system, the unit must be connected to a general electricity supply in accordance with the following regulations:

Upstream, the general electricity supply must be protected by a 30 mA differential switch.

The heat pump must be connected to a suitable D-curve circuit breaker (see table below) in accordance with current standards and regulations in the country where the system is installed.

The electricity supply cable must be adapted to match the unit's rated power and the length of wiring required by the installation (see table below). The cable must be suitable for outdoor use.

For a three-phase system, it is essential to connect the phases in the correct sequence. If the phases are inverted, the heat pump's compressor will not work.

In places open to the public, it is mandatory to install an emergency stop button close to the heat pump.

Models	Electricity supply	Max. current	Cable diameter	Protection Thermal-magnetic (D curve) protection
Silent Max 80	Single-phase 220-240V/1N~50Hz	9 A	RO2V 3x2,5 mm ²	10 A
Silent Max 125		13 A	RO2V 3x2,5 mm ²	16 A
Silent Max 150		15 A	RO2V 3x2,5 mm ²	20 A

¹ Cable cross-section suitable for max. length 10 metres. For longer than 10 metres, consult an electrician.

3. Installation

3.8 Electrical connection



WARNING: The heat pump's power supply MUST be disconnected before any operation.

Please comply with the following instructions to electrically connect the heat pump.

Step 1: Detach the electrical top panel with a screwdriver to access the electrical terminal block.

Step 2: Insert the cable into the heat pump unit by passing it through the opening provided for that purpose.

Step 3: Connect the power supply cable to the terminal block in accordance with the diagram below.

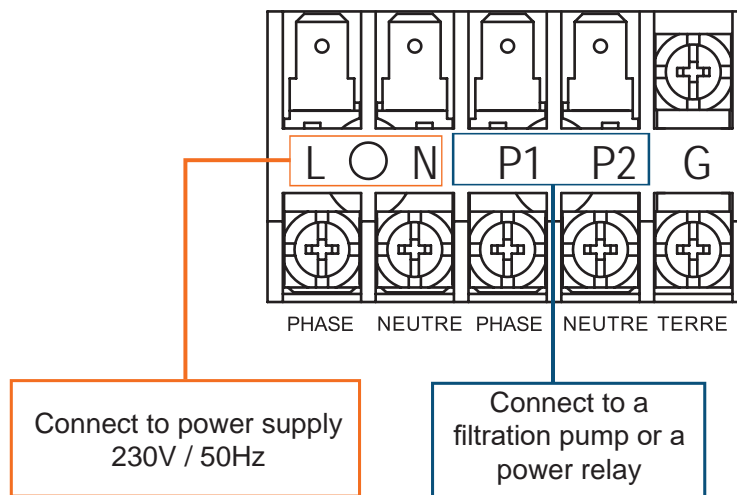

Step 4: Carefully close the heat pump panel.

Servo-control of circulating pump

Depending on the type of installation, you can also connect a circulating pump to terminals P1 and P2 (230V powered contact) so that this operates in tandem with the heat pump.



WARNING: Servo-control of a pump whose power exceeds 5A (1000W) requires the use of a power relay.

4. Use

4.1 Wired remote control

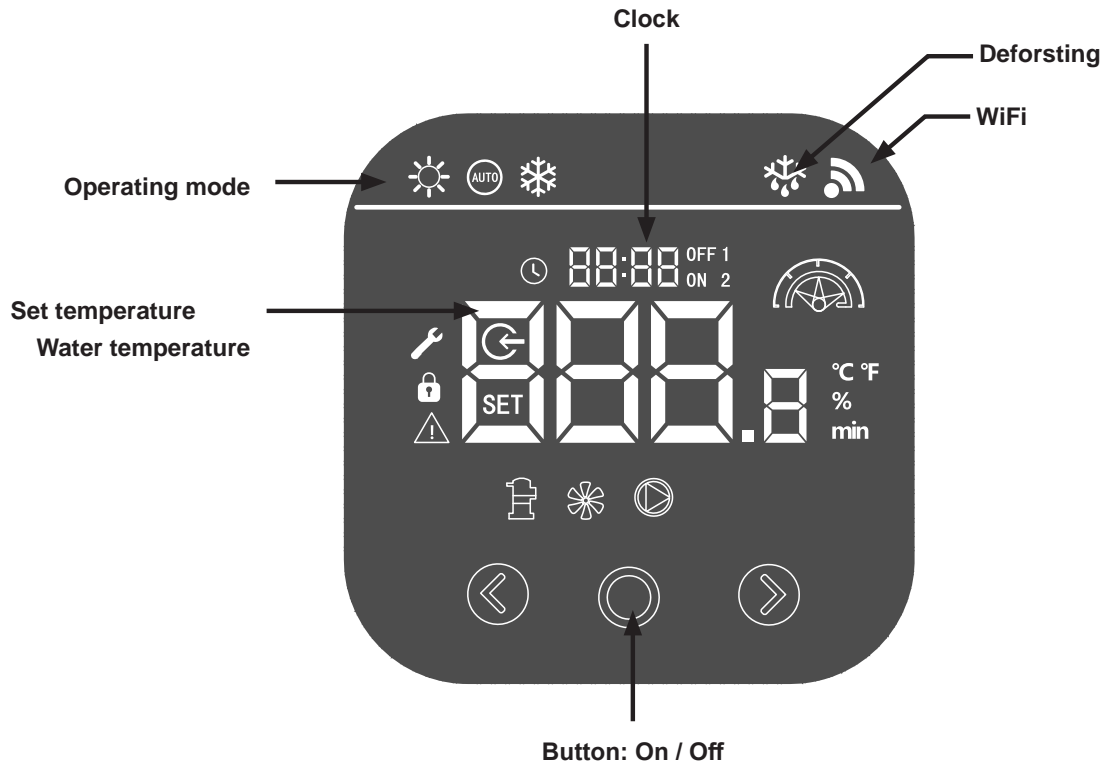

Before you start, make sure the filtration pump is running and that water is flowing through the heat pump.

Before setting your set temperature, you must choose the operating mode of your heat pump first

Other indications of the control box

Heating	Clock	Water inlet temp.	Failure
Auto	Current time	Set temp.	Compressor
Cooling	Timer On/Off	Value	Fan
Defrosting	Mode compressor speed	Humidity unit	Water pump
WiFi	Parameters	Lock	

4. Use

4.2 Start-up and locking

Press  3 s to unlock the control box.

Press  2s to turn the heat pump on or off. This button is also used to return to the main interface.



The lock activates automatically after 60 seconds of inactivity). When the cabinet is locked, the logo  appears.



4.3 Operating modes



Press the button  to change the operating mode:

Then press the right arrow to change the operating mode



press  again to validate the change and return to the main menu



 +  **SILENT Heating mode:** Choose this heating mode so that the heat pump operates silently.



 +  **ECO Heating mode:** Choose this heating mode for the heat pump to operate in a conventional manner.

 +  **BOOST heating mode:** Choose this heating mode so that the heat pump quickly heats the water in your pool.

 **Auto mode:** The heat pump intelligently chooses the most appropriate operating mode according to the setpoint temperature.

 +  **SILENT Cooling mode:** Choose this cooling mode for the heat pump to operate silently.

 +  **ECO Cooling mode:** Choose this cooling mode so that the heat pump operates in a conventional manner.

 +  **BOOST Cooling mode:** Choose this cooling mode for the heat pump to operate in a classic way.

Good to know



WARNING: When the cooling mode switches to heating mode or vice-versa, the heat pump will restart after 10 minutes.

When the incoming water temperature is less than or equal to the required temperature (setpoint temperature - 1°C), the heat pump will switch to heating mode. The compressor will stop when the temperature of the incoming water is greater than or equal to the required temperature (setpoint temperature + 1°C).

4. Use

4.4 Setting the required temperature

Step 1: Go to the main menu by unlocking the control panel.

Step 2: Press the ◀ and ▶ buttons to change the set temperature.



4.5 Clock setting

Step 1: Go to the main menu by unlocking the control panel.

Step 2: Press the Ⓞ 2 times to enter the clock setting interface. The clock display ⌚ flashes.

Step 3: Press the ▶ button to switch from hours to minutes and validate by pressing Ⓞ

Step 3: Change the hours using the ◀ and ▶ buttons.

Step 4: Press the button Ⓞ 1s to confirm the setting and return to the main menu.





4. Use

4.6 On / Off synchronization adjustment



This function is used to program the start and stop time. You can program up to 3 different starts and stops. The setting is done as follows:



Step 1: Go to the main menu by unlocking the control panel.



Step 2: Press the  button to enter the setting of the On / off groups.



Step 3: the icon  flashes.

Step 4: Press  to choose mode 1 or 2.

Step 5: Press  to switch to the «ON» hour setting, modify with the  and  buttons.

Step 6: Press  to switch to the «ON» setting for the minutes, modify with the  and  buttons.

Step 7: Press  to go to the «OFF» hour setting, modify with the  and  buttons.

Step 8: Press  to go to the 'OFF' minute setting, modify with the  and  buttons.

Step 9: Press  to confirm the settings and return to the main menu.



4.7 Activation / deactivation of On / Off groups

Groups can be activated / deactivated at any time. The setting is as follows:

Step 1: Go to the main menu by unlocking the control panel.

Step 2: Press  **three time** to enter the setting of the On / off groups.

Step 3: the icon  flashes.

Step 4: Press . The «1» flashes.

Step 5: Press  2s to activate or deactivate timer 1 or 2. If «1» is fixed, group 1 is activated.

Step 6 : Press  to confirm the settings and return to the main menu.



4. Use

4.8 Downloading & Installing the «Smart Life» app

About the Smart Life app:

You'll need to create a «Smart Life» account to control your heat pump remotely.

The «Smart Life» app lets you control your home appliances from anywhere. You can add and control multiple devices at once.

- Also compatible with Amazon Echo and Google Home (depending on the country).
- You can share your devices with other Smart Life accounts.
- Receive real-time operational alerts.
- Create scenarios with several devices, depending on the app's weather data (geolocation required).

For more information, go to the «Help» section of the «Smart Life» app

The «Smart Life» app and services are provided by Hangzhou Tuya Technology. Poolstar, owner and distributor of the Poolex brand, cannot be held responsible for the operation of the «Smart Life» app. Poolstar has no visibility on your «Smart Life» account.

iOS :

Search for «Smart Life» in the App Store to download the app:

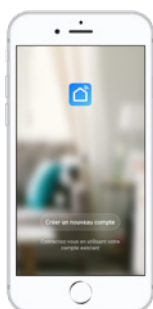

Check the compatibility of your phone and the version of your OS before installing the application

Android :

Search for «Smart Life» on Google Play to download the app :

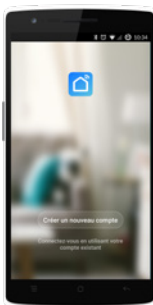

Check the compatibility of your phone and the version of your OS before installing the application

4. Use

4.9 Setting up the app



WARNING : Before you begin, make sure you have downloaded the «Smart Life» app, connected to your local WiFi network, and that your heat pump is electrically powered and running.

You'll need to create a «Smart Life» account to control your heat pump remotely. If you already have a Smart Life account, please log in and go directly to step 3.

Step 1 : Click on «Create new account» and choose to register by «Email» or «Phone,» where a verification code will be sent to you.

Enter your email address or phone number and click «Send verification code».

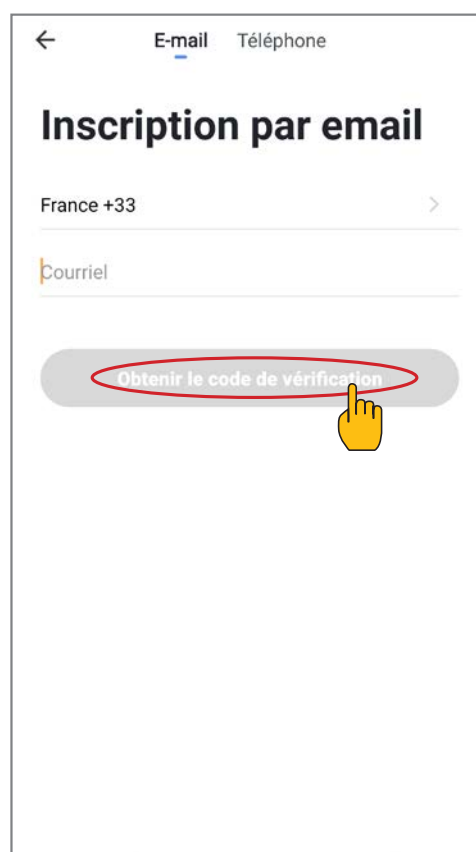
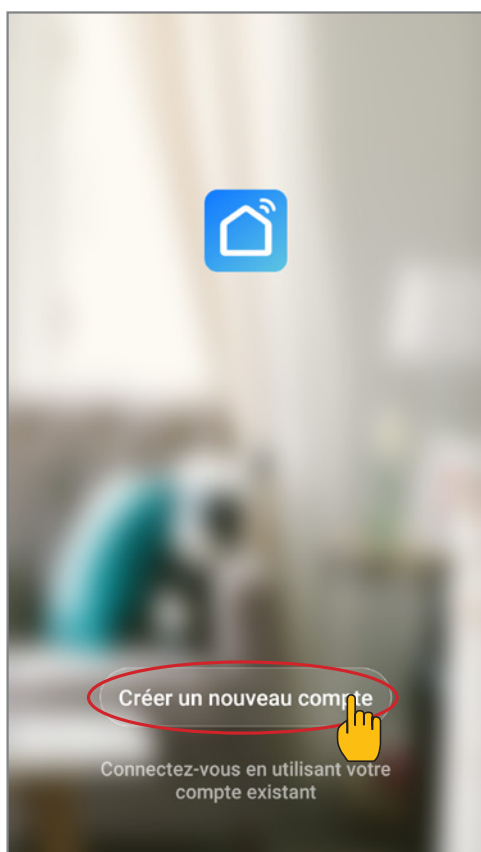

Step 2 : Enter the verification code received by email or phone to validate your account.

Congratulations! You are now part of the «Smart Life» community.

4. Use

Step 3 (Recommended): Add an object by clicking «...» and then «Add Object.» Enter its name («Pool» for example), then click «Done.»

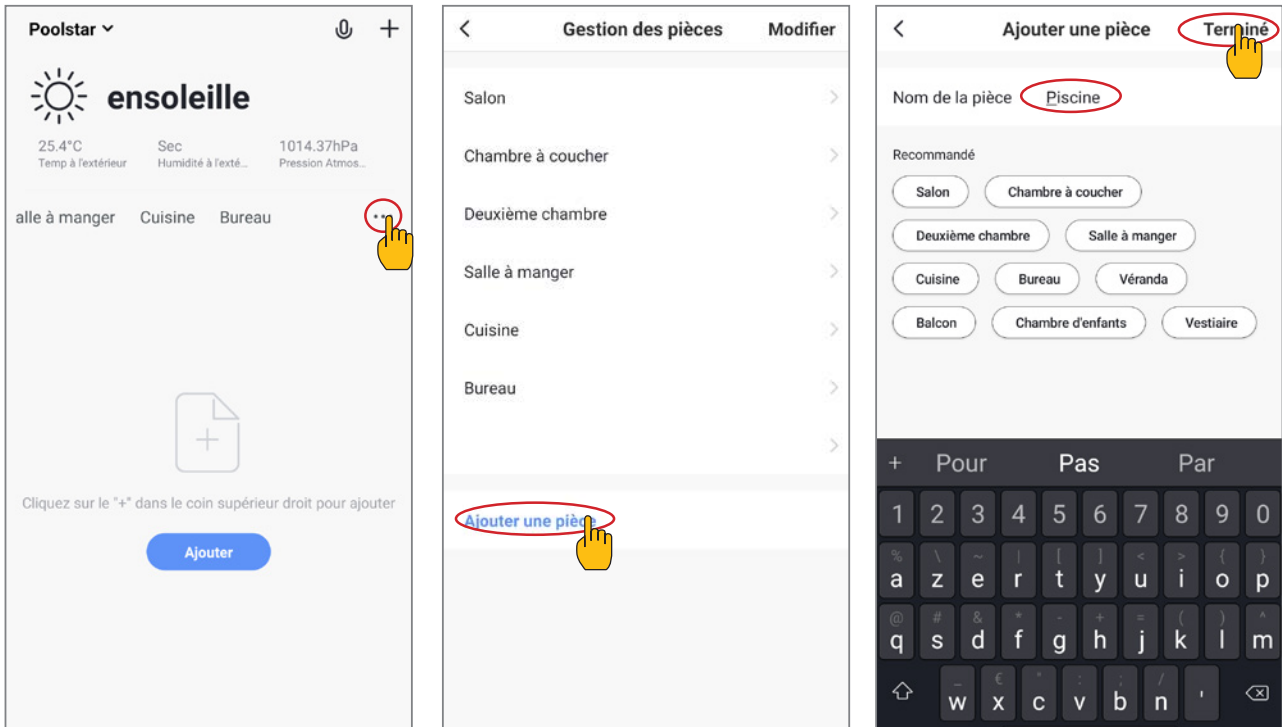

Step 4 : Now add a device to your «Pool»

Click «Add» or «+» and then «Large appliances...» followed by «Water heater.»

At this point, leave your smartphone on the «Add» screen and go to the pairing step for your control box.

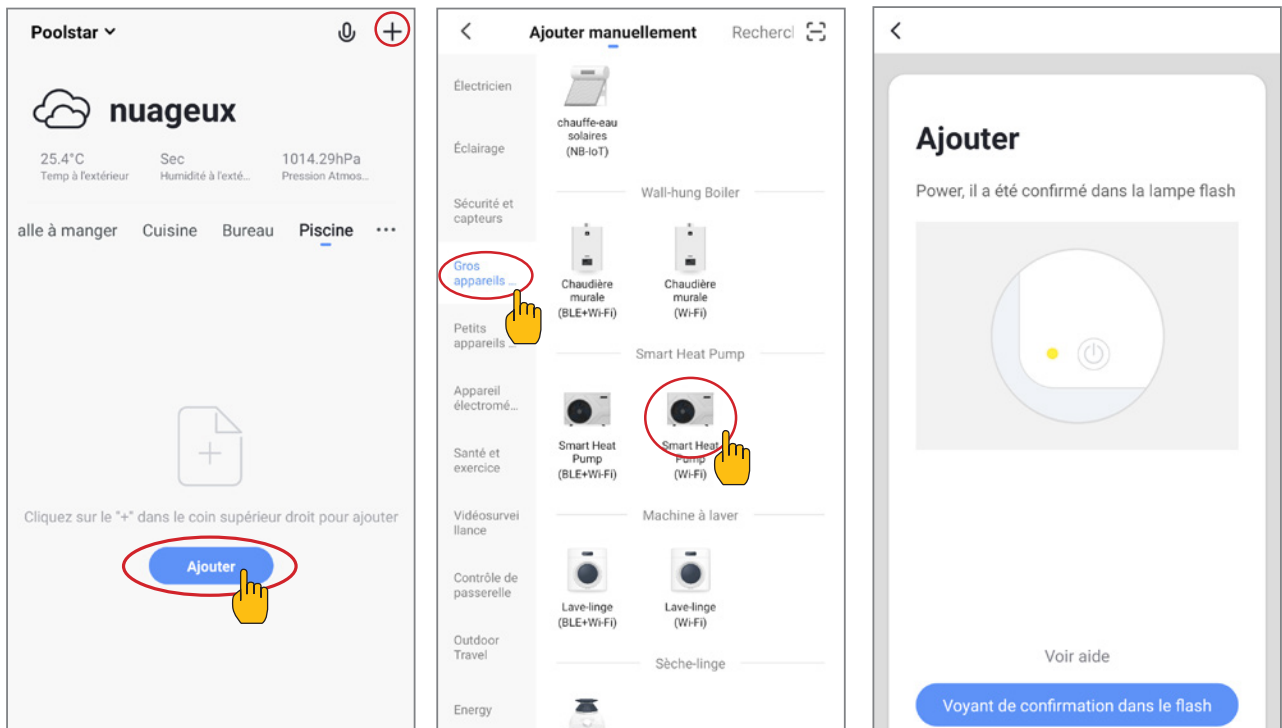

4. Use

4.10 Pairing the heat pump

4.10.1 EZ Mode

Step 1 : Now start the pairing.

Choose your home WiFi network, enter the WiFi password and press «Confirm».

Step 2 : Activate the pairing mode on your heat pump according to the following procedure:

The procedure depends on the model of your control box:

CAUTION The «Smart Life» application only supports 2.4GHz WiFi networks.

If your WiFi network uses the 5GHz frequency, go to the interface of your home WiFi network to create a second 2.4GHz WiFi network (available for most Internet boxes, routers and WiFi access points).



The pairing is successful, you can rename your Poolex heat pump then press «Done».
Congratulations, your heat pump can now be controlled from your smartphone.



Press + simultaneously for 5s, flashes quickly, the control box is ready to be paired.

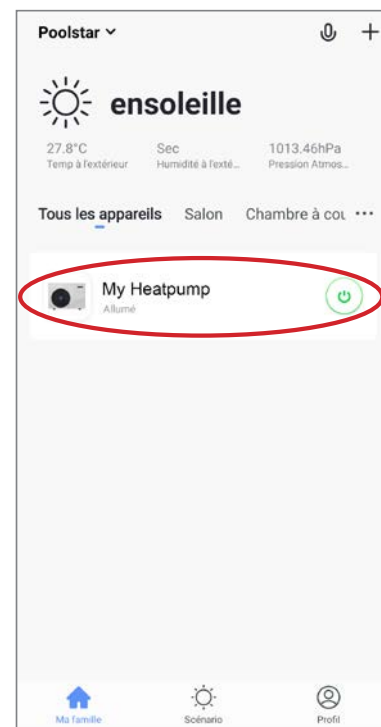
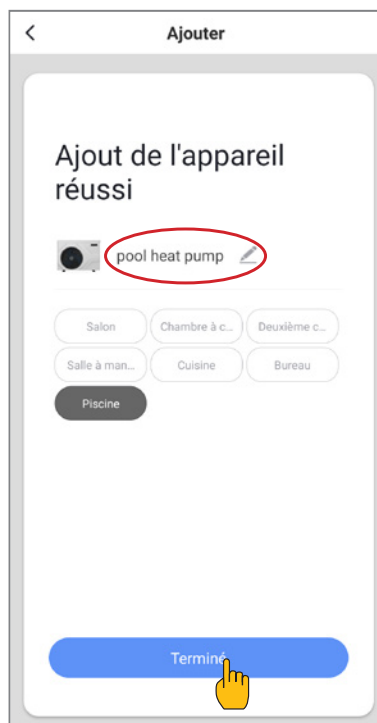

Note: The flashing stops when the box is connected to WiFi

4. Use

4.11 Controlling

Interface

- 1 Current pool temperature
- 2 Temperature setpoint
- 3 Current operating mode
- 4 Switch the heat pump on/off
- 5 Change the temperature
- 6 Change the operating mode
- 7 Set the operating range



Configure the operating ranges for the heat pump

Step 1 : Create a schedule, choose the time, day(s) of the week(s), and the action (turn on or off) and save.

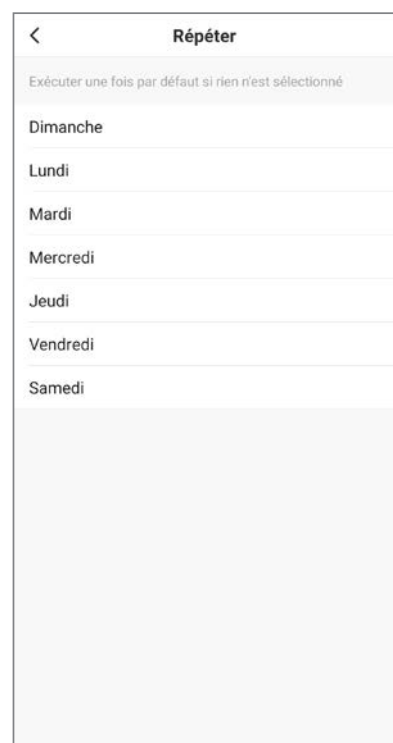
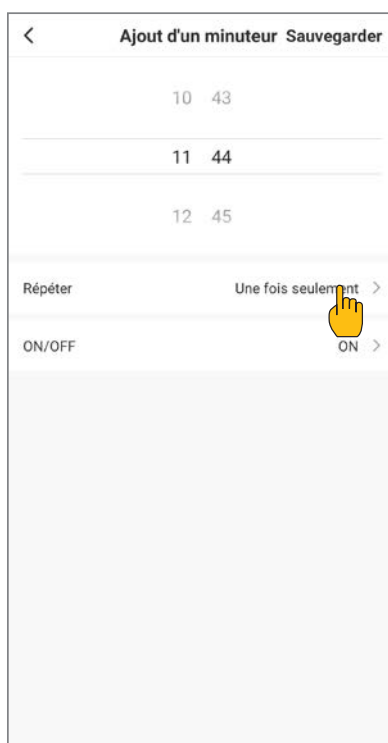
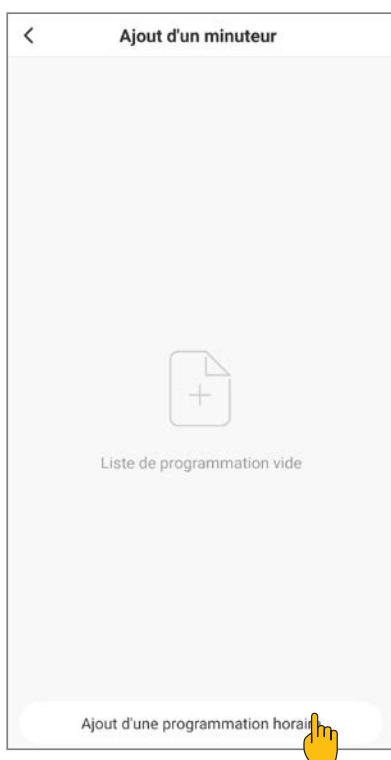

Step 2 : To delete a time slot, press on it and hold.

4. Use

Choice of operating modes

For Inverter heat pumps :

You can choose between Inverter Heating, Cooling, Eco (Silent) or On/ Off (Manual) modes.

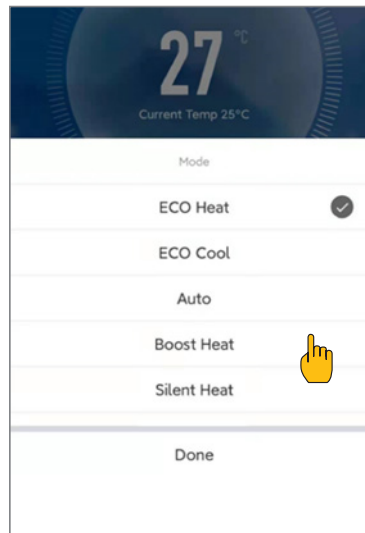

Available modes

Inverter heating*
Inverter cooling*
On/Off (FIX)*
Eco Inverter*

*Some modes may change depending on the machines

5. Operation

5.1 Operation

Conditions of use

For the heat pump to operate normally, the ambient air temperature must be between -10°C and 43°C.

Recommendations prior to start-up

Before activating the heat pump, please:

- ✓ Check that the unit is firmly secured and stable.
- ✓ Check that the gauge indicates a pressure greater than 80 psi.
- ✓ Check that the electrical wiring is properly connected to the terminals.
- ✓ Check the earthing.
- ✓ Check that the hydraulic connections are tight and that there is no leakage of water.
- ✓ Check that the water is circulating correctly in the heat pump and that the flow rate is adequate.
- ✓ Remove any unnecessary object or tool from around the unit.

Operation

1. Activate the unit's power supply protection (differential switch and circuit-breaker).
2. Activate the circulating pump if it is not servo-controlled.
3. Check the By-Pass opening and the control valves.
4. Activate the heat pump by pressing once on 
5. Adjust the remote control clock.
6. Select the required temperature by using one of the remote control's mode.
7. The heat pump's compressor will start up after a few moments.

All you have to do now is wait until the required temperature is reached.



WARNING: Under normal conditions, a suitable heat pump can heat the water in a swimming pool by 1°C to 2°C per day. It is therefore quite normal to not feel any temperature difference in the system when the heat pump is working. A heated pool must be covered to avoid any loss of heat.

5.2 Servo-control of circulating pump

If you have connected a circulating pump to terminals P1 and P2, it is automatically electrically powered when the heat pump operates.

5. Operation

5.3 Using the pressure gauge

The gauge is for monitoring the pressure of the refrigerant contained in the heat pump. The values it indicates can vary considerably, depending on the climate, temperature and atmospheric pressure.

When the heat pump is in operation:

The gauge's needle indicates the refrigerant pressure.

Mean operating range between 250 and 400 PSI, depending on the ambient temperature and atmospheric pressure.

When the heat pump is shut down:

The needle indicates the same value as the ambient temperature (within a few degrees) and the corresponding atmospheric pressure (between 150 and 350 PSI maximum).

If left unused for a long period of time :

Check the pressure gauge before starting up the heat pump. It must indicate at least 80 PSI.

If the pressure goes down too much, the heat pump will display an error message and automatically go into 'safe' mode.

This means that there has been a leakage of refrigerant and that you must call a qualified technician to replace it.

5.4 Antifreeze protection



WARNING: For the antifreeze system to work, the heat pump must be powered and the circulating pump activated. If the circulating pump is servo-controlled by the heat pump, it will be automatically activated.

When the heat pump is on standby, the system monitors the ambient temperature and the water temperature in order to activate the antifreeze programme if required.

The antifreeze programme is automatically activated when the ambient temperature or the temperature of the water is less than 2°C and when the heat pump has been shut down for more than 120 minutes.

When the antifreeze programme is running, the heat pump activates its compressor and the circulating pump so as to reheat the water until the water temperature exceeds 2°C.

The heat pump automatically leaves the antifreeze mode when the ambient temperature is greater than or equal to 2°C or when the heat pump is activated by the user.

6. Maintenance and servicing

6.1 Maintenance and servicing



WARNING: Before undertaking maintenance work on the unit, ensure that you have disconnected the electrical power supply.

Cleaning

The heat pump's casing must be cleaned with a damp cloth. The use of detergents or other household products could damage the surface of the casing and affect its properties.

The evaporator at the rear of the heat pump must be carefully cleaned with a vacuum cleaner and soft brush attachment.

Annual maintenance

The following operations must be undertaken by a qualified person at least once a year.

- ✓ Carry out safety checks.
- ✓ Check the integrity of the electrical wiring.
- ✓ Check the earthing connections.
- ✓ Monitor the state of the pressure gauge and the presence of refrigerant.

6.2 Winter storage

In the winter months when the ambient temperature is lower than 3°C, a shut-down heat pump must be winterised to avoid any frost damage.

Winterising in 4 steps



Step 1
Disconnect the heat pump from the power supply.

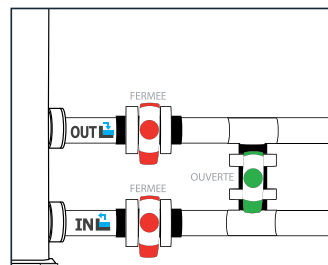

Step 2
Open the By-Pass valve. Close the inlet and outlet valves.

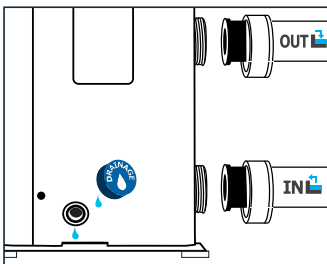

Step 3
Unscrew the drain plug and water pipes in order to drain any water from the heat pump.

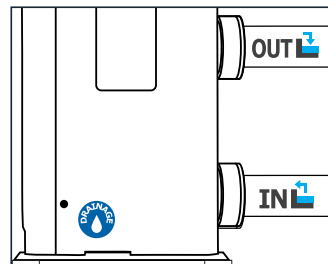

Step 4
Screw back the drain plug and pipes or block them with rags so as to prevent any foreign bodies from getting into the circuit. Finally, protect the pump with its winter storage cover.



If a circulating pump is servo-controlled by the heat pump, drain this also.

7. Repairs



WARNING: Under normal conditions, a suitable heat pump can heat the water in a swimming pool by 1°C to 2°C per day. It is therefore quite normal to not feel any temperature difference in the system when the heat pump is working.
A heated pool must be covered to avoid any loss of heat.

7.1 Breakdowns and faults

In the event of a problem, the heat pump's screen displays a fault symbol  instead of temperature indications. Please consult the table opposite to find the possible causes of a fault and the actions to be taken.

Fault code examples:



7.2 Advanced status values settings



WARNING : This is to facilitate maintenance and future repairs.
Only an experienced professional is authorized to modify the default parameters.







WARNING : Any modification of the parameters reserved automatically results in the cancellation of the guarantee.

System settings can be checked and changed using the remote control by following the steps below



Step 1: Press the button  until the icon **SET** flashes to enter the general heat pump settings.



Step 2: Press the arrow  to enter the password 168.

Step 3: enter the correct value using the  and  buttons, then validate with the button 

Step 4: Scroll through the codes of the main parameters using the  and  buttons.

Step 5: Press the button  to enter the desired setting.

Step 6: Modify the desired value with the  and  buttons.

Step 7: Press the button  to validate the value change, then long press  to return to the main menu.



7. Repairs

7.3 List of faults

Code	Anomalies	Causes possibles	Actions
FL0	Flow sensor malfunction	Not enough water in the exchanger	Check the good circulation of water in the heat pump, and the opening of the inlet / outlet valves of the By Pass
		Sensor disconnected or defective	Reconnect or replace the sensor
AL01	Discharge temp. sensor failure	Sensor disconnected or defective	Reconnect or replace the sensor
AL02	Suction temp. sensor failure	Sensor disconnected or defective	Reconnect or replace the sensor
AL03	Malfunction of the inlet water temperature sensor	Sensor disconnected or defective	Reconnect or replace the sensor
AL04	Water outlet temperature sensor malfunction	Sensor disconnected or defective	Reconnect or replace the sensor
AL06	Ambient temperature sensor malfunction	Sensor disconnected or defective	Reconnect or replace the sensor
AL07	Connection problem between the electronic card and the wired remote control	Bad connection	Check the connection cables between the remote control and the electronic card
		Wired remote control defective	Replace the remote control
		Defective electronic board	Replace the electronic card
AL08	EEPROM failure	Main PCB failure	replace PCB
		EEPROM not correct	Update new EEPROM
AL09	Fan motor failure	Fan motor failure	Check or replace fan motor
		PCB failure	Check or replace PCB
		Fan blade failure	Check or replace fan blade
AL11 / AL12	High and low pressure switch failure	Gas system blocked	Check the gas system
		Fan motor failure	Check fan motor
		Gas leakage	check the gas amount
		Pressure switch failure	check or replace pressure switch
AL14	ambient temp. protection	Out of operating range	turn off the machine
		sensor failure	check or replace new sensor
AL15	Water temperature too high at the outlet for heating mode	Insufficient water flow	Check the good circulation of water in the heat pump, and the opening of the inlet / outlet valves of the By Pass
AL17	Evaporator temperature too high (> 60 ° C) for cooling mode	The fan does not work or the air inlets / outlets are blocked	Check the correct operation of the fan
		Refrigerant overload	Readjust the refrigerant charge
AL18	Exchanger sensor malfunction	Sensor disconnected or defective	Reconnect or replace the sensor
AL19	Supply voltage too high / Low	Feeding problem	Review the power to the heat pump
AL20	Power supply too high / Low	Feeding problem	Review the power to the heat pump
AL21	Incorrect internal voltage	Incorrect power cabling	Review the device connection diagram
AL22	Compressor malfunction		
AL23	IPM malfunction		

7. Repairs

Code	Anomalies	Causes possibles	Actions
AL24	Motherboard malfunction		
AL25	Driver card security	Overheating	<ul style="list-style-type: none"> - Switch off the heat pump and then restart it - Check the compressor power cable (connection and condition) - Replace the motherboard - Replace the compressor
AL28	Protection of the inverter module	Restart the heat pump	If the problem persists, replace the inverter module
AL29	Frost protection in standby		
AL30	Water outlet temperature too high		
AL31	Exchanger temperature too high		
AL32	Exchanger sensor malfunction		

8. Warranty

8.1 General warranty conditions

The Poolex Company guarantees the original owner against defective materials and faults in the manufacture of the Poolex heat pump for a period of two (2) years.

The compressor is guaranteed for a period of five (5) years.

The titanium tube heat exchanger is guaranteed for a period of fifteen (15) years against chemical corrosion, except for frost damage.

The condenser's other components are guaranteed for two (2) years.

The warranty becomes effective on the date of the first invoice.

The warranty does not apply in the following cases:

- Malfunction or damage arising from an installation, usage or repair that is not in compliance with the safety instructions.
- Malfunction or damage arising from a chemical agent that is unsuitable for the pool.
- Malfunction or damage arising from conditions that are unsuitable for the equipment's purposes of use.
- Damage arising from negligence, accident or force majeure.
- Malfunction or damage arising from the use of unauthorised accessories.

Repairs undertaken during the warranty period must be approved prior to being carried out by an authorised technician. The warranty shall be null and void if the repair to the equipment is carried out by a person who is not authorised by the Poolex company.

The guaranteed parts shall be replaced or repaired at Poolex's discretion. Defective parts must be returned to our workshops to be covered during the warranty period. The warranty does not cover labour costs or unauthorised replacements. The return of the defective part is not covered by the warranty.

Dear,

Please take a few minutes to fill out a warranty card
that you will find on our website:

<http://assistance.poolex.fr/>

We thank you for your confidence
and wish you an excellent swim.

Your contact details may be processed in accordance with the Data Protection Act
dated January 6, 1978 and will not be disclosed to anyone.



9. Appendices

9.2 Default values







CAUTION : This operation is used to facilitate maintenance and future repairs.
Only an experienced professional is authorized to change the default settings

System settings can be checked and changed using the remote control by following the steps below

Step 1: Press  until the icon  flashes to enter the general heat pump settings.

Step 2: Press .

Step 3: Enter the correct value using the  and  buttons, then validate with .

Step 4 : Long press  to return to the main menu.



9. Appendices

N°	Description	Default value
T1	Discharge Temp.	
T2	Suction Temp.	
T3	Water Inlet temp.	
T4	Water outlet temp.	
T5	Coil Temp.	
T6	Ambient Temp.	
T7	IPM temp.	
T8	id coil temp.	
T9	Reserve	
T10	Reserve	
T11	Reserve	
Ft	Target frequency	
Fr	Current frequency	
1F	Main EEV opening	
2F	Slave EEL opening	
od	Operation mode	1:Cooling 4:Heating
Pr	Fan speed	AC : 1 High / 2:middle / 3:Low DC : value *10
dF	Defrosting condition	
OIL	Oil return condition	
r1	Reserve	
r2	Bottom plate heater on/off	
r3	Reserve	
STF	4 way valve switch	
HF	Reserve	
PF	Reserve	
PTF	Reserve	
Pu	Water pump on/off	
AH	AC fan high speed on/off	
Ad	AC fan middle speed on/off	
AL	AC fan low speed on/off	
dcU	DC main line voltage	
dcC	Inverter compressor current (A)	
AcU	Input voltage	
AcC	Input current	
HE 1	History error code	
HE 2	History error code	
HE 3	History error code	
HE 4	History error code	

9. Appendices

9.3 Main parameters







CAUTION : This operation is used to facilitate maintenance and future repairs.
Only an experienced professional is authorized to change the default settings

System settings can be checked and changed using the remote control by following the steps below



Step 1: Press the button  until the icon **SET** flashes to enter the general heat pump settings.



Step 2: Press the arrow  to enter the password 138.

Step 3: enter the correct value using the  and  buttons, then validate with the button 

Step 4: Scroll through the codes of the main parameters using the  and  buttons.

Step 5: Press the button  to enter the desired setting.

Step 6: Modify the desired value with the  and  buttons.

Step 7: Press the button  to validate the value change, then long press  to return to the main menu.



Code	Name	Range	Default
L0	Water pump operation mode	0 : always ON 1 : compressor Off, water pump 60s delay off, and per L1 minutes turn on 5 minutes	1
L1	Compressor off, water pump operating period	Compressor off, per "L1" minutes turn on 5 minutes, L1=3 to 180min	30
L2	Timer setting valid	0 : Invalid 1 : Valid	1
L3	Memory function	0 OFF, 1=ON	1
L4	Back light setting	0 : no light 1 : lightning 2 : Off after 30 seconds without operating	2
L5	Unit operation mode	0 : heating only 1 : cooling only 2 : heating cooling 3 : cooling, heating, auto, boost heating, silent heating, boost cooling, silent cooling	3

POOLEX

✓RoHS CE

TECHNICAL ASSISTANCE

www.poolex.fr