



PROTEAM XXS Swimming Pool Heat Pump

Installation & Operation Manual



Model: XXS-3

XXS-4

XXS-6

⚠ Please keep installation manual in a safe place and read it carefully before using.

- The unit must be installed by professional technicians according to this manual.

- If the unit is installed in an area that is prone to lightning strikes, please ensure to take appropriate lightning protection measures.

- The manufacturer shall not be responsible for any damage caused to people, objects or equipment due to failure to follow the instructions and comply with the procedures contained in this manual. Any use of this product for functions other than described in the manual shall be considered as dangerous.

- Make sure the heat pump is installed in a well-ventilated place, away from anything which could cause fire.

- Do not weld any pipes if there is refrigerant inside machine. If you need to fill gas into the unit, make sure it is in an open, well-ventilated area and not in a confined space.

- Always drain all water inside the heat pump during winter or when the ambient temperature drops below 0°C: failure to do so may result in damage to the titanium heat exchanger due to freezing, and it will not be covered by warranty.

- Always disconnect the power supply if you want to open the cabinet to look inside the heat pump as there is high voltage electricity inside.

- Make sure the display controller is in a dry area to prevent damage caused by humidity.

- Filling of gas must be carried out by professionals with R32 operating license.

*** INDEX**

- 1. Specifications**
- 2. Dimensions**
- 3. Installation and connection**
- 4. Electrical wiring**
- 5. Display controller operation**
- 6. Troubleshooting**
- 7. Exploded diagram**
- 8. Maintenance**

1. Specifications

1.1 Technical data pool heat pumps

Model	XXS-3	XXS-4	XXS-6
Advised pool volume(m3)	≤ 20	≤ 28	≤ 37
Power Supply	220V~240V/1/50Hz		
Heating Capacity at Air 26°C,Water 26°C Hygro 80%			
Heating Capacity (Kw)	3.05	4.00	5.60
Power Input (kW)	0.56	0.73	1.03
COP	5.45	5.45	5.43
Heating Capacity at Air 15°C,Water 26°C Hygro 70%			
Heating Capacity (kW)	2.51	3.10	4.95
Power Input (kW)	0.55	0.69	1.09
COP	4.53	4.52	4.54
Max Power Input (kW)	0.95	1.28	1.55
Max Current (A)	4.4	5.8	7.0
Refrigerant	R32	R32	R32
Heat Exchanger	Titanium	Titanium	Titanium
Air Flow Direction	Horizontal	Horizontal	Horizontal
Water Flow Volume (m ³ /h)	1.5	2.0	3.0
Net Dimensions (L*W*H) (mm)	380*280*350	380*280*350	420*360*436
Package Dimensions (L*W*H) (mm)	440*355*405	440*355*405	480*435*495
Working temperature range (°C)	8~43	8~43	8~43
Noise (dB)	28	29	29
Net Weight (kg)	18	20	24
Gross Weight (kg)	20	22	26

*Above data is subject to modification without prior notice.

2. Dimensions

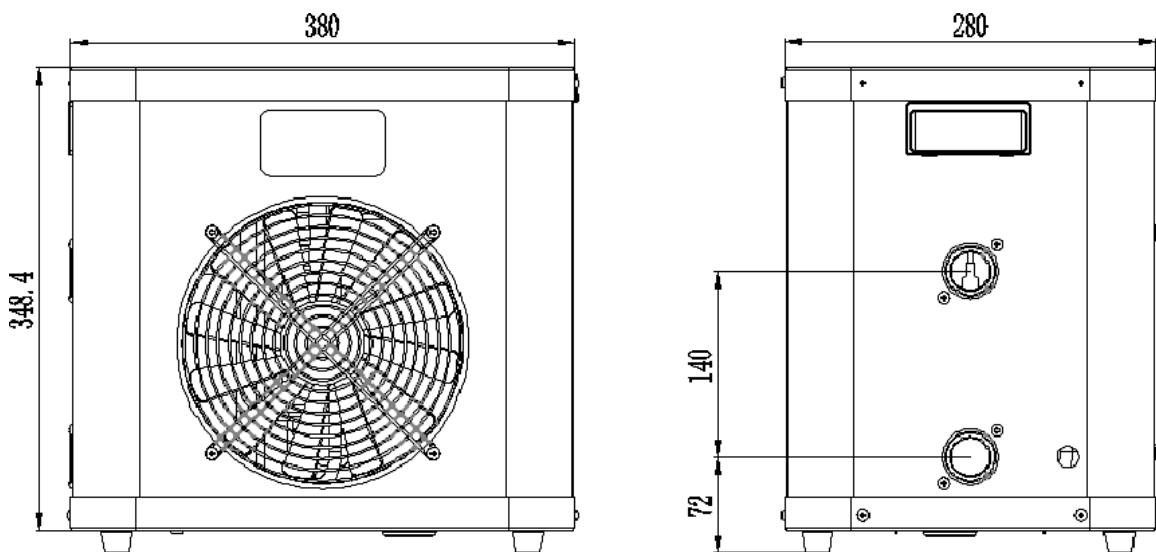

3. Installation and connection

Attention:

Please observe the following rules when installing the heat pump:

1. Any addition of chemicals must take place in the piping located **downstream (after)** from the heat pump.
2. Always keep the heat pump in an upright position. If the unit has been held at an angle, wait at least 24 hours before starting the heat pump.

3.1 Heat pump location

The unit will work properly in any desired location as long as the following three requirements are met:

1. Fresh air
2. Electricity
3. Swimming pool filters

The unit may be installed in virtually any **outdoor** location as long as the specified minimum distances to other objects are maintained. Please consult your installer for installation on an indoor pool.

ATTENTION: Never install the unit in a closed room with limited space (air volume) in which the air expelled from the unit will be reused, or close to shrubbery that could block the air inlet. Such locations impair the continuous supply of fresh air, resulting in reduced efficiency and possibly preventing sufficient heat output.

3.2 Initial operation

Note: In order to heat the water in the pool (or hot tub), the filter pump must be running so that water is circulated through the heat pump. The heat pump will not start up if the water is not circulating.

3.3 Electrical connection

Before connecting the unit, verify that the supply voltage matches the operating voltage of the heat pump.

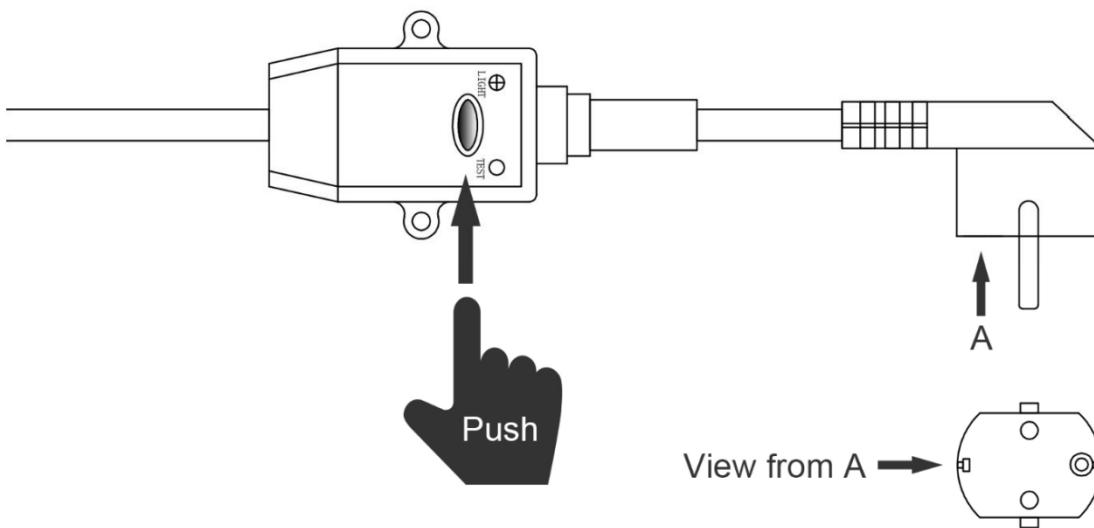

An RCD plug has been included with the power cable to provide electrical protection.

Attention:

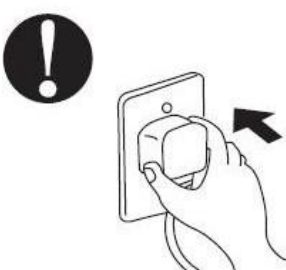
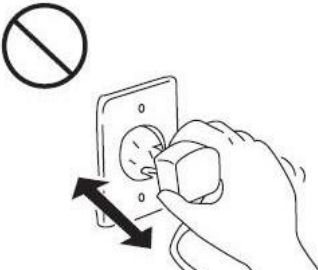
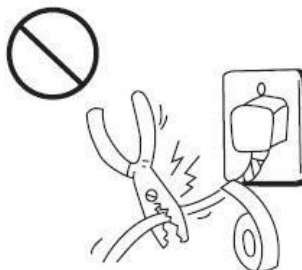
<p>Ensure the power plug is secure</p> <p>If the plug is not secure, it may cause an electric shock, over-heating or fire.</p> 	<p>Never pull out the power plug during operation</p> <p>This may cause an electric shock or a fire due to over-heating.</p> 	<p>Never use damaged electric wires or unspecified electric wires.</p> <p>This may cause an electric shock or a fire.</p> 
---	---	--

After all connections have been made and checked, carry out the following procedure:

1. Switch on the filter pump. Check for leaks and verify that water is flowing from and to the swimming pool.
2. Connect power to the heat pump and press the On/Off button  on the control panel. The unit will start up after the time delay expires (see below).
3. After a few minutes, check whether the air blowing out of the unit is cooler.
4. When you turn off the filter pump, the unit should also switch off automatically.

Depending on the initial temperature of the water in the swimming pool and the air temperature, it may take some time to heat the water to the desired temperature. A good swimming pool cover can dramatically reduce the required length of time to heat the pool and the energy required to maintain the desired temperature.

Time delay - The heat pump has a built-in 3-minute start-up delay to protect the circuitry and avoid excessive contact wear. The unit will restart automatically after this time delay expires.

The first time the unit power is switched on or after any power interruptions, the heat pump starts 10s after pressing 'ON/OFF' button.

3.4 Condensation

The air drawn into the heat pump is quickly cooled by the operation of the heat pump to heat the pool water, which may cause condensation on the fins of the evaporator. The amount of condensation may be as much as several litres per hour at high relative humidity. This is sometimes mistakenly regarded as a water leak.

4. Electrical wiring

4.1 Swimming pool heat pump wiring diagram

3kW

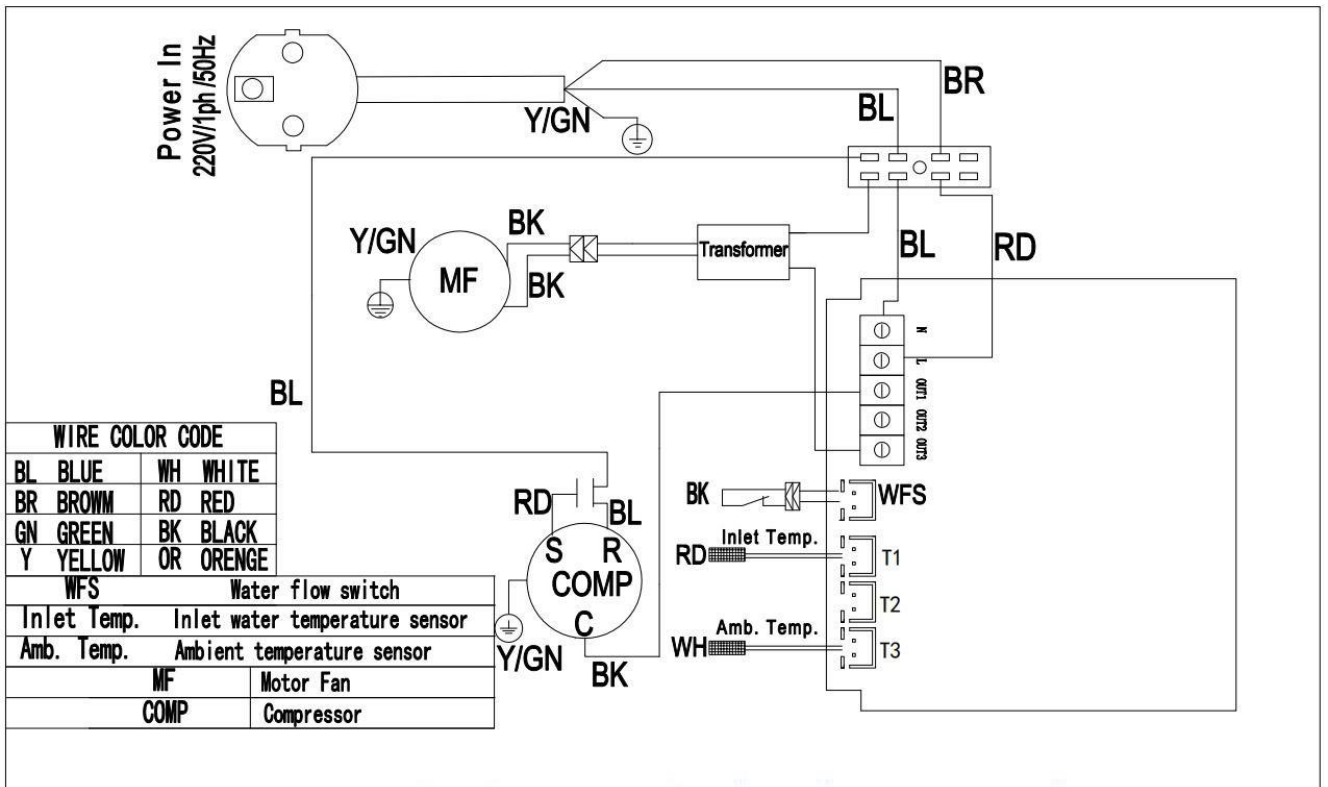

NOTE:

- (1) The above electrical wiring diagram is only for your reference, please check the wiring diagram on the unit.
- (2) The swimming pool heat pump must be properly grounded/earthed. Even though the heat exchanger is electrically isolated from the rest of the unit, grounding the unit is still required to protect against short circuits inside the unit.

Disconnect: A disconnection device (circuit breaker, fused or un-fused switch) should be located within sight of and readily accessible from the unit. This is common practice on commercial and residential heat pumps. It prevents remotely energizing unattended equipment and permits turning off power at the unit while the unit is being serviced.

5. Display controller operation

5.1 LED wire controller Interface

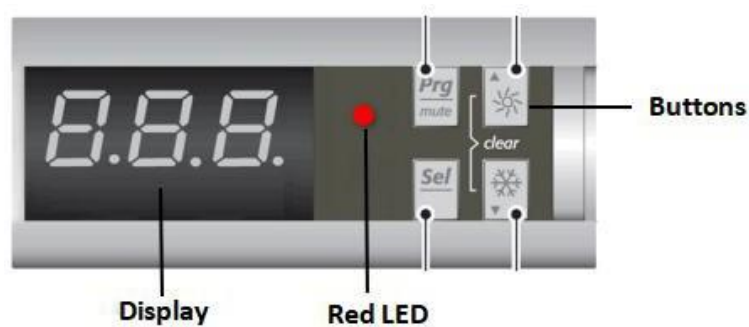

* When the heat pump is running or on standby, the display shows the water inlet temperature.

* When the heat pump is powered on, the display shows 'OFF'

* Red LED will go on when you turn on the machine.

5.2 Turn on/off the heat pump



Press  to turn on the heat pump, the LED display shows the water setting temperature for 5s, and then shows the water inlet temperature.





Press  again to turn off the heat pump.

NOTE: There is a 3 min time delay at start-up to protect the compressor.

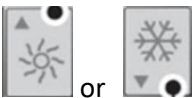
5.3 Set the desired water temperature





Press  or  directly to adjust the desired water temperature (parameter d, range: 15–40 °C), the setting will be saved after 3 seconds.

You can also adjust Parameter d to set the desired water temperature.





NOTE: the heat pump can run only if the water circulation/filtration system is running.

5.4 Parameter checking & adjustment

Hold  button for 5 seconds to enter parameter checking mode, Press  or  to check the



Parameters shown below.

NOTE: The other parameters which are not shown below are reserved for other functions and are not applicable to this unit.

Press  again to enter the current parameter adjustment screen, press  or  to make the adjustment, then press  to save the setting.

Parameter	Description	Range	Default	Remark
A	Inlet water temp.	-19~99℃		Real data
C	Ambient temp.	-19~99℃		Real data
d	Desired water temp.	15℃~40℃	27℃	Adjustable
H	Return ambient temp. difference	1℃~10℃	2℃	Adjustable
J	Power-failure protection	0~1	1 (Yes)	Adjustable
O	Lowest ambient temp. for operation	0℃~15℃	10℃	Adjustable

5.5 Restore factory settings

Hold  and  for 10 seconds to restore the factory settings.

6. Troubleshooting

6.1 Error code on the LED controller

Malfunction	Code	Reason	Solution
Water temperature sensor failure	P1	Water temperature sensor open circuit or short circuit.	1. Check the sensor wiring. 2. Replace the water temperature sensor.
Ambient temperature sensor failure	P5	Ambient temperature sensor open circuit or short circuit.	1. Check the sensor wiring. 2. Replace the ambient temperature sensor.
Too low or too high ambient temperature protection	P7	1. Ambient temperature is out of operating range: 10°C - 42°C. 2. Controller failure.	1. Wait until the ambient temperature rises to 12°C or cools down to 40°C to restart. 2. Replace the controller.
Water flow failure	E3	1. Insufficient or no water flow. 2. The wiring of the water flowswitch is loose.	1. Check the water pump or water piping system. 2. Check the wiring or replace the water flow switch.

6.2 Other Malfunctions and Solutions (not displayed on LED wire controller)

Malfunctions	Observing	Reason	Solution
	LED wire controller no display.	No power supply.	Check that power cable and circuit breaker are connected properly.

Heat pump is not running	LED wire controller displays the actual water temperature.	<ol style="list-style-type: none"> 1. Water temperature is reaching the set value, unit is under constant temperature status. 2. Heat pump has just started running. 	<ol style="list-style-type: none"> 1. Check water temperature setting. 2. Start up heat pump after a few minutes.
Short running	LED displays actual water temperature, no error code displays.	<ol style="list-style-type: none"> 1. Fan NOT running. 2. Air ventilation is not enough. 3. Refrigerant is not enough. 	<ol style="list-style-type: none"> 1. Check the cable connections between the motor and fan: reconnect or replace if necessary. 2. Check the location of heat pump and eliminate all obstacles to ensure good air ventilation. 3. Replace or repair the unit.
Water stains	Water stains on heat pump unit.	<ol style="list-style-type: none"> 1. Condensate water. 2. Water leakage. 	<ol style="list-style-type: none"> 1. No action. 2. Check the titanium heat exchanger carefully for any defect.

7.Exploded diagram

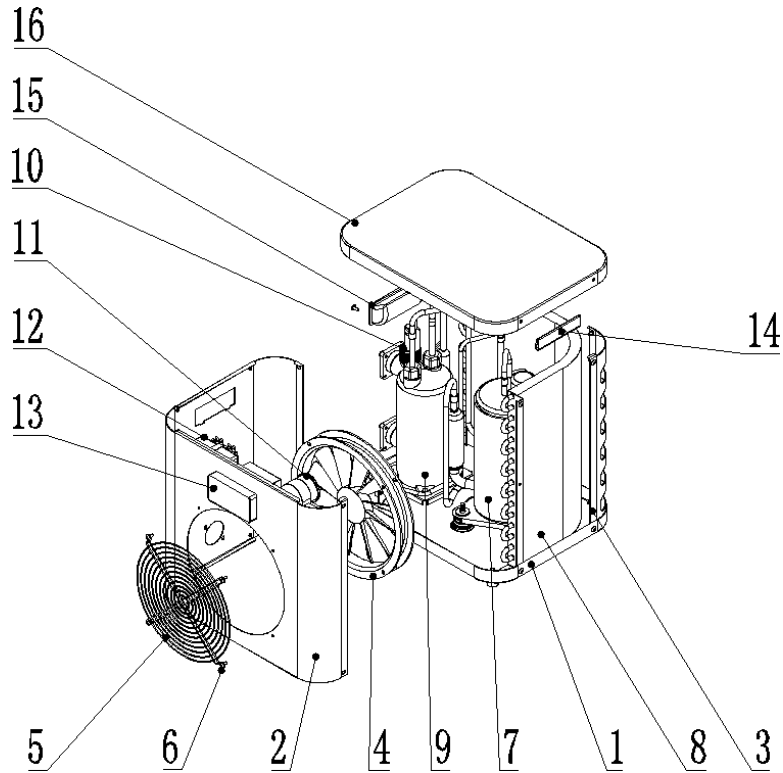

No.	Name	No.	Name
1	Base tray	9	Titanium heat exchanger
2	Front panel	10	Water flow switch
3	Back support	11	Capacitor
4	Fan blade	12	Switch
5	Fan grill	13	Controller
6	M4 screw	14	Handle
7	Compressor	15	Handle
8	Evaporator	16	Top cover

8. Maintenance

- (1) Check the water supply system regularly to make sure that no air is entering the system and to check for low water flow, as this could result in reduced performance and reliability of the unit.

- (2) Clean your pool and filtration system regularly to prevent damage to the unit as a result of a dirty or clogged filter.

- (3) Drain all water from the unit if it will not be used for a long time (especially during winter).

- (4) Before restarting the unit, check that it is filled with water.

- (5) When the unit is running, there is always some water discharge under the unit (due to condensation as described above).



Automated Environmental Systems, Unit B, Anglian Lane, Bury St Edmunds, IP32 6SR
01284 658770 | sales@automatedenvironmentalsystems.co.uk