



EPIC 1D

RANGE 0,37÷15 kW
0,50÷20 Hp

Installation
and use
manual

Introduction

1.1 PRESENTATION	pag. 3
1.2 DESCRIPTION	pag. 3
1.3 HANDLING	pag. 3

Safety informations

2.1 WARNINGS	pag. 4
2.2 CAUTION	pag. 4

Installation

3.1 ASSEMBLING	pag. 5
3.2 ELECTRICAL CONNECTIONS	pag. 6
3.3 ADJUSTMENTS AND SETTINGS (INITIALIZATION)	pag. 8
3.4 ADJUSTMENTS AND SETTINGS (ADVANCED MENU)	pag. 10
3.5 TRIMMER SETTINGS	pag. 25
3.6 CONTACT ALARM OUTPUTS	pag. 25

General use

4.1 KEYPAD AND LIGHTS INDICATIONS	pag. 27
4.2 ALARMS	pag. 28
4.3 TYPICAL INSTALLATIONS	pag. 30

Maintenance

5.1 PUMPS STOP	pag. 32
5.2 SERVICE	pag. 32
5.3 SPARE PARTS	pag. 32
5.4 WASTE DISPOSAL	pag. 32

Certifications

6.1 CERTIFICATE OF CONFORMITY	pag. 33
-------------------------------	---------

1.1 PRESENTATION

The purpose of this manual is to provide the necessary information for the proper installation, use and maintenance of EPIC 1D.

The user should read this manual before operating the unit. Improper use may cause damage to the machine and lead to the forfeiture of the warranty coverage. Always specify the model identification code and the construction number when requesting technical information or spare parts from our Sales and Service department. The instruction and warnings given below concern the standard version; refer to the sale

contract documentation for modifications and special version characteristics. For instructions, situations and events not considered in this manual or in the sale documents, please contact our customer service.

Our units must be installed in sheltered, well-ventilated, non-hazardous environments and must be used at a maximum temperature of +40°C and minimum of -5°C.

1.2 DESCRIPTION

These control panels are designed for controlling 1 motor or electric pump used in pressurization systems or in applications for emptying wells or water tanks. In case of any failure of the main pump, the reserve pump start automatically.

voltage protection (V); phase failure protection; start and stop delay; delay network restore, protection delay, frequency 50-60Hz.

Atlantic S.r.l.s shall not be liable for any damage caused or suffered by the unit as a result of its unauthorised or improper use.

OUTPUT ALARMS AND PROTECTIONS

Acoustic alarm; light alarm, alarm output Relais 220V CA, alarm output Relais 12 V CC, alarm output with Buzzer 12 V; min-max water level; min-max Voltage; phase failure; frequency failure alarm; min-max motor Amperage; min cosφ; motor klixon alarm; water in oil chamber alarm.

TECHNICAL FEATURES

Self learning of the motor data; min-max amperage protection (A); dry running protection made by cosφ and min Amperage; min and max

1.3 HANDLING

The control panel must be handled with care, as falls and knocks can cause damage without any visible external signs.

STORED

If for any reason the unit is not installed and starter immediately after it has reached its destination it must be stored properly. The external packaging and the separately packed accessories must remain intact, and the whole must be protected from the weather, especially from freezing temperatures, and from any knocks or falls.

PRELIMINARY INSPECTION

After you have removed the external packaging, visually inspect the control panel to make sure it has suffered no damage during shipping. If any damage is visible, inform an Atlantic dealer as soon as possible, no later than five days from the delivery date.

2.1 WARNINGS



RISK OF ELECTRIC SHOCK

Failure to follow the instructions in this manual, carries a risk of electric shock.



RISK FOR PEOPLE AND PROPERTY

Failure to follow the prescriptions in this manual, carries a risk of damage to persons and/or property.



WARNING

Failure to observe the prescriptions in this manual, cause damage to the pump, the unit or the system.

2.2 CAUTION



ATTENTION: PUMPS

- Make sure the pumps are fully primed before you start it.
- Make sure the pumps are running with the correct rotation.
- The electric pumps or the motors can start up automatically.



ATTENTION: ELECTRICAL CONNECTION

- The control panel must be connected by a qualified electrician in compliance with the electrical regulations in force.
- The electric pumps or the motors and the panel must be connected to an efficient grounding system in compliance with the electrical regulations locally in force.
- Ground the unit before carrying out any other operation.



ATTENTION: SERVICE

As a general rule, always disconnect the power supply before proceeding to carry out any operation on the electrical or mechanical components of the unit or system.

3.1 ASSEMBLING

Fix the control panel for a stable support with screws and screw anchor using the holes arranged in the box (pic. 1) or the fixing bracket if present.

To fix the cables in their terminals use a tool of the proper size to avoid the damaging of the screws or of their seat.

If use an electric screwier pay attention not to spoil the thread or the screws.

After the fixing, remove every plastic or metallic surplus (ex. Pieces of copper of the cables or plastic shavings of the box) inside the box before supplying power.

LINE OF SUPPLY CURRENT

Connect the unit at ground before carrying out any other operation.

The voltage input corresponds to the data written on the panel and on the pump:

- (400V ± 10% 50/60Hz x il EPIC 1D -400/...)
- (230V ± 10% 50/60Hz x il EPIC 1D -230)

Make sure that the power-supply-cable can bear the nominal current and connect it to the terminals of the general switch of the control panel.

If the cables are exposed, they must be appropriately protected.

The line must be protected with an Earth leakage and magnetic switch measured in accordance with the regulations locally in force.

LINE OF MOTOR POWER SUPPLY

Connect the unit at ground before carrying out any other operation.

The voltage input corresponds to the data written on the motor:

- (400V±10% 50/60Hz three-phase)
- (230V±10% 50/60Hz single-phase)

Doing some starting make sure that the motor respects the right direction of rotation usually indicated by an arrow printed on the motor.

3.2 ELECTRICAL CONNECTIONS

EPIC 1D 230

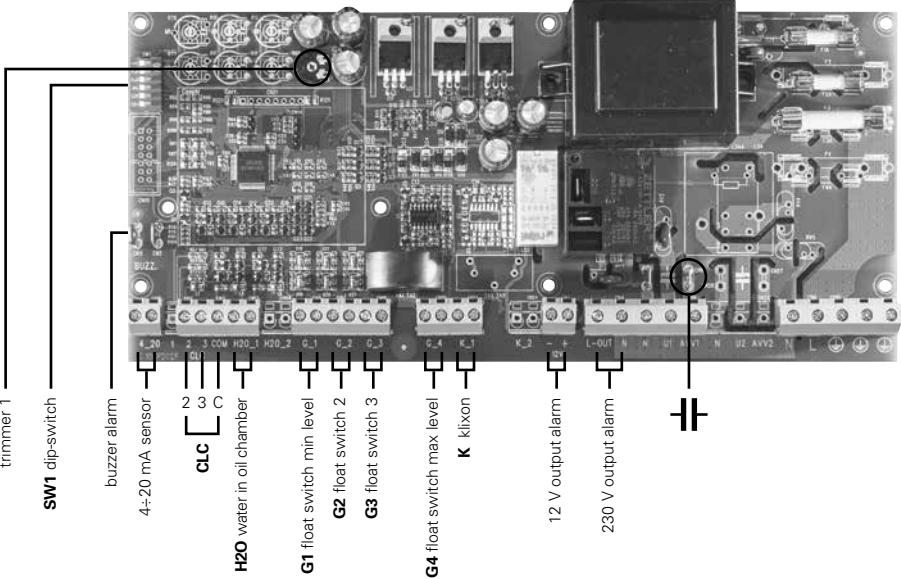
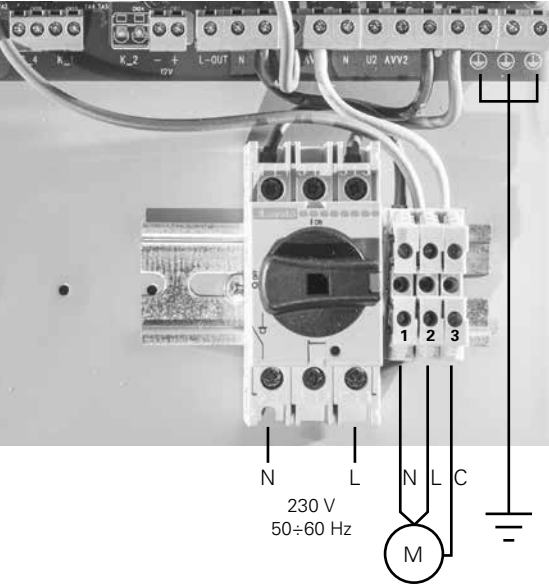

EPIC 1D 400

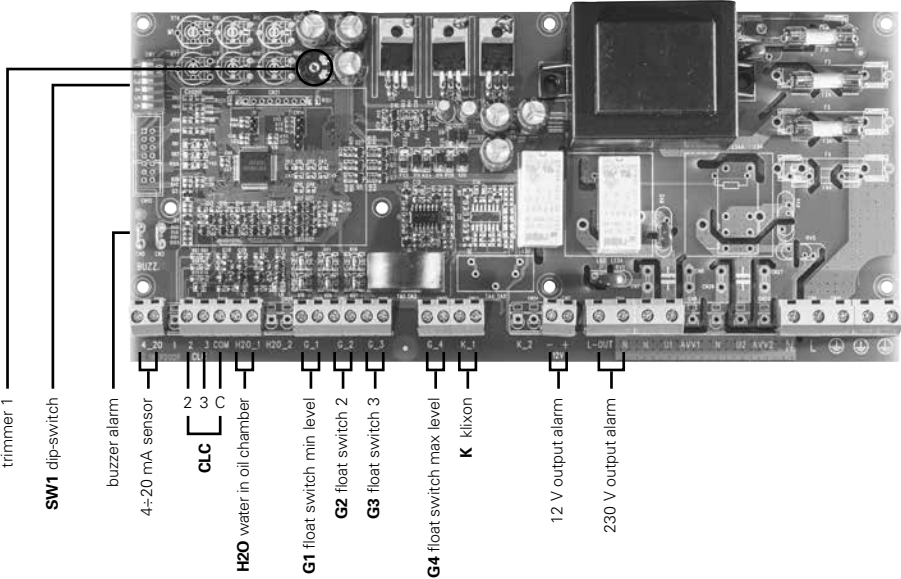
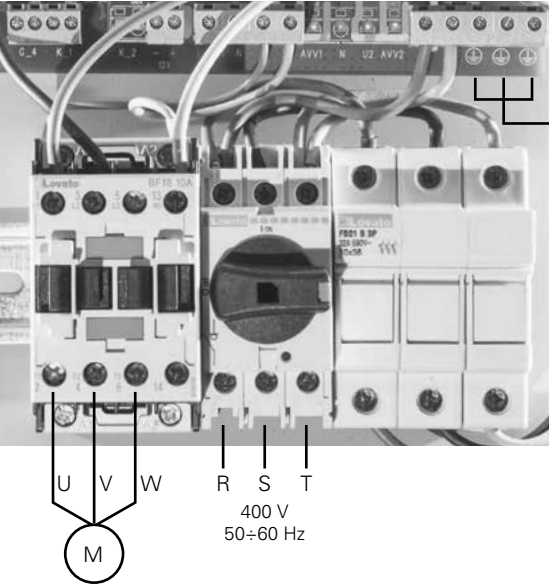

3.3 ADJUSTMENTS AND SETTINGS (INITIALIZATION)

CONTROL PANEL TURN ON

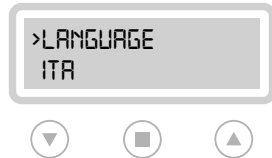

After making all the electrical connections, switch on the control panel and wait for the initial message to appear on the display.

LANGUAGE SETTING (OBLIGATORY)



Select the display language by scrolling the menu with the appropriate arrows (step 1 and 2).

When completed, press the confirm button (step 3) to continue.

PUMP TRIGGER

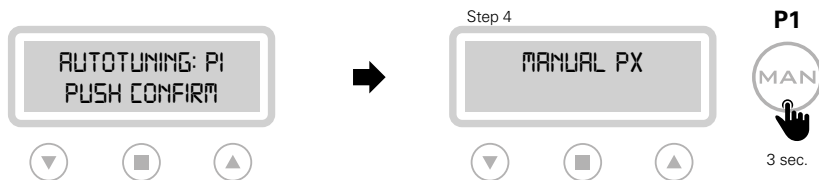

To proceed with self-learning procedure, the pump must first be triggered.

Do not press confirm, but start the pumps, keeping the "MAN" button pressed (for 3 sec.).

AUTOTUNING (OBLIGATORY)



To start the self-learning of the pump data, type reply (step 5).

For the final confirmation of the data (step 7) type "YES", or enter "NO" to go back (to step 5).



Before starting the self-learning procedure, it is necessary to check with a tester that the mains voltage corresponds to the nominal one or at least to the mains voltage.



IMPORTANT!

After pressing the final confirmation button, self-learning is no longer possible. To perform the self-learning again it is necessary to access the advanced menu (3.4).

CONTROL PANEL OPERATIVITY



Once the self-learning phase is completed, the display of the panel displays the data learned.

By pressing the "AUT" P1 button the panel becomes operational.

PRESET PARAMETERS

LANGUAGE: selected	STOP DELAY: 1 sec.
TURN ON DELAY: 2 sec.	OPERATION: emptying
MANUAL KEY: unstable	TYPE: potable
START DELAY: 4 sec.	SELF HOLDING: on

3.4 ADJUSTMENTS AND SETTINGS (ADVANCED MENU)

ACCESS TO ADVANCED MENU

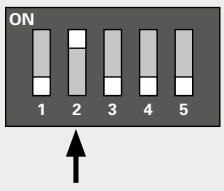

ON

1 2 3 4 5

DIP-SWITCH 2

The control panel is set as standard with the dip-switch 2 in the "OFF" position. To access the "ADVANCED MENU" and modify the various parameters, **switch off the control panel and set dip-switch 2 to "ON"**. Then turn the control panel back on to display the message on the "ADVANCED MENU" on the display.



SETTING
PARAMETERS [OK]



→



EXIT

M01 UTILITY
M02 GENERAL
M03 NET CONTROL
M04 PUMP 1

M06 PROGRAM

M07 SENSOR
M08 TIMER
EXIT

CONFIRM MODIFICATIONS AND EXIT FROM ADVANCED MENU (EXAMPLE)



LANGUAGE
>ENG

→



M01 UTILITY
>LANGUAGE

→



>M01 UTILITY
LANGUAGE



>M01 UTILITY
M02 GENERAL

→



>EXIT
M01 UTILITY

→

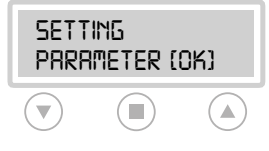

SETTING
PARAMETER [OK]

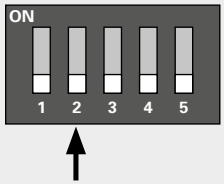

ON

1 2 3 4 5

DIP-SWITCH 2

Once the setting of the various parameters has been confirmed (for example the LANGUAGE parameter), to exit the "ADVANCED MENU" **bring the dip-switch 2 back to the "OFF" position**.

M01 UTILITY

ACCESS TO FUNCTION

MODIFIED PARAMETERS



>M01 UTILITY
M02 GENERAL

LANGUAGE

Language selection

START DELAY

Control panel switch-on delay after restart (in sec.)

MANUAL KEYPAD

Possibility of operating the "MAN" button in stable or unstable mode
ON: unstable
OFF: stable



CHANGE LANGUAGE



M01 UTILITA'
>LINGUA

→

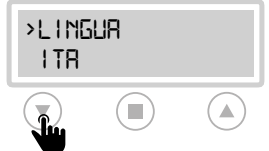

>LINGUA
ITA

→

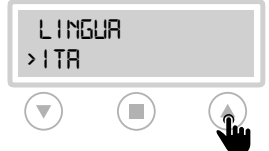

LINGUA
>ITA

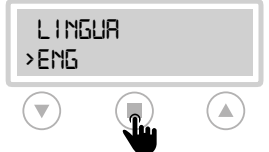

LINGUA
>ENG

→

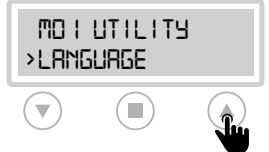

M01 UTILITY
>LANGUAGE

→



>EXIT

CHANGE START DELAY



M01 UTILITY
>START DELAY

→

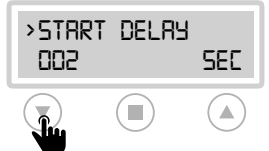

>START DELAY
002 SEC

→

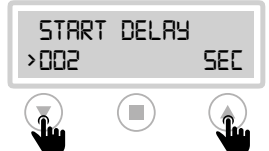

START DELAY
>002 SEC

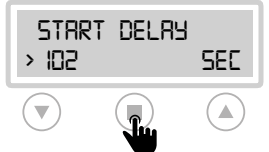

START DELAY
>102 SEC

→



M01 UTILITY
>START DELAY

→



>EXIT

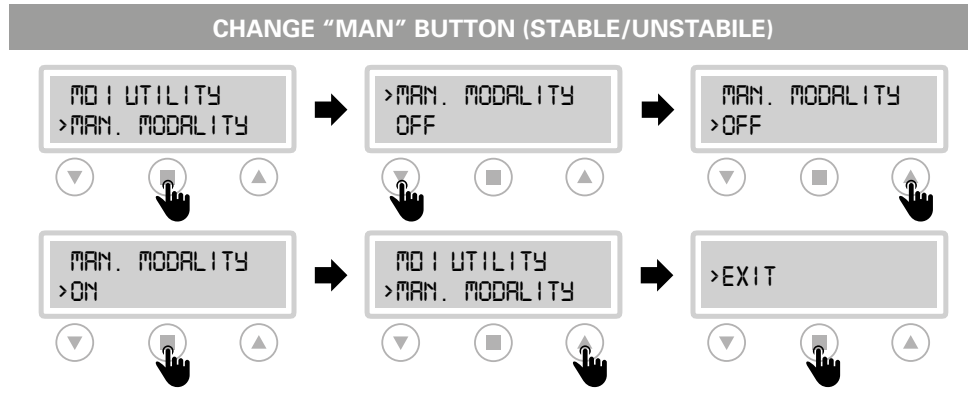

M02 GENERAL

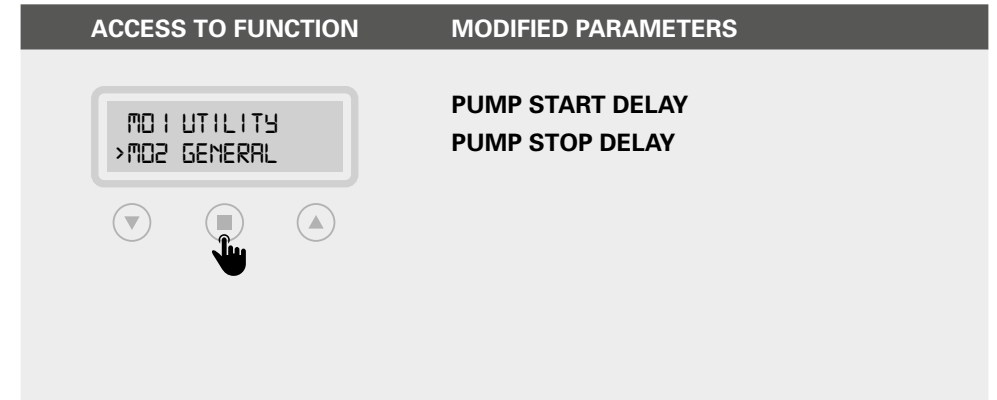

CHANGE START DELAY

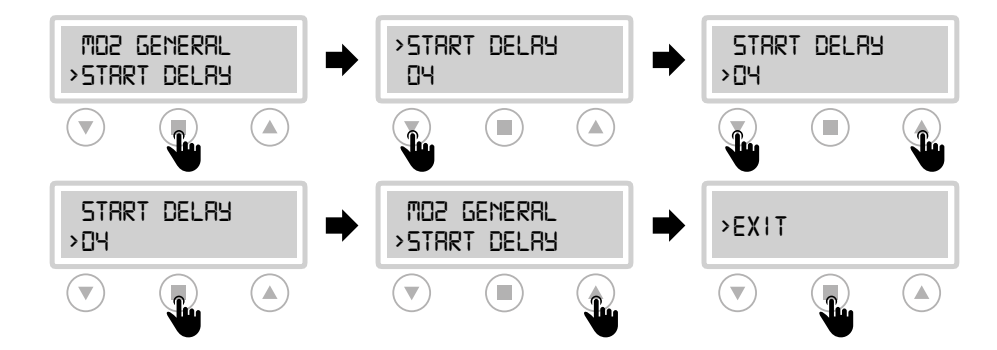

CHANGE STOP DELAY

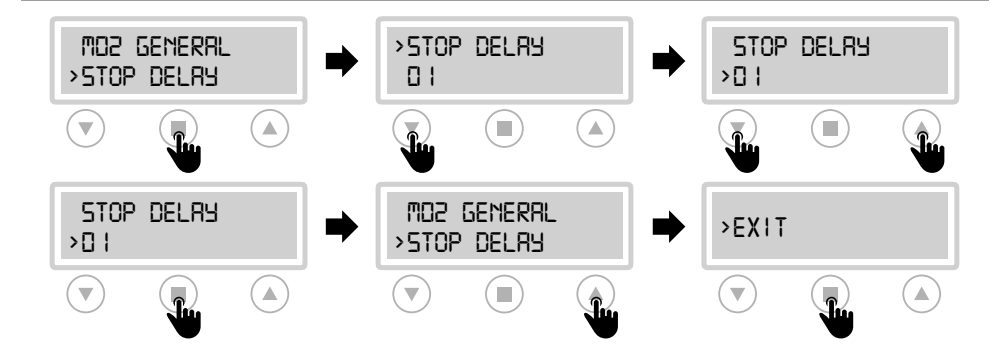

M03 NET CONTROL

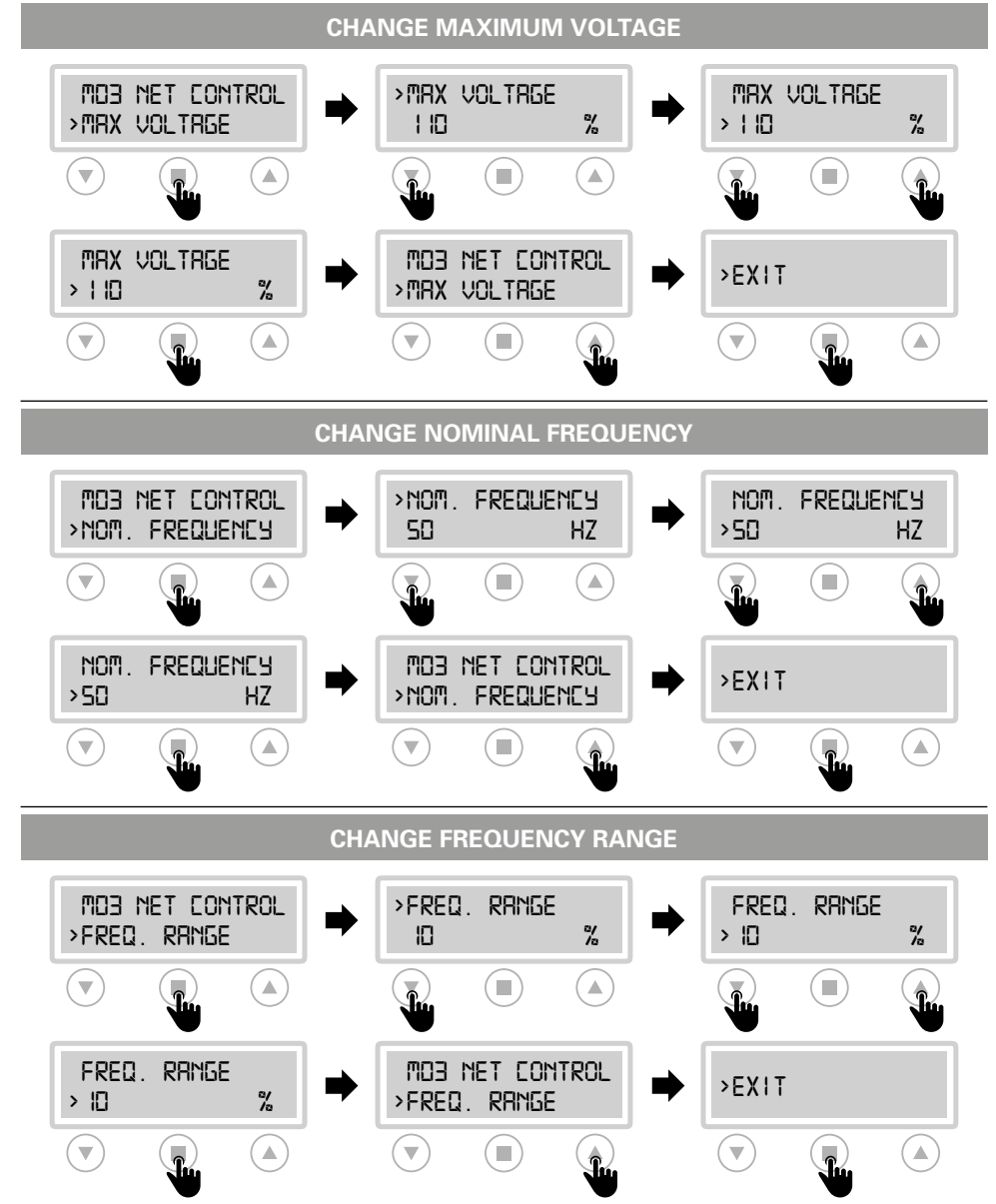
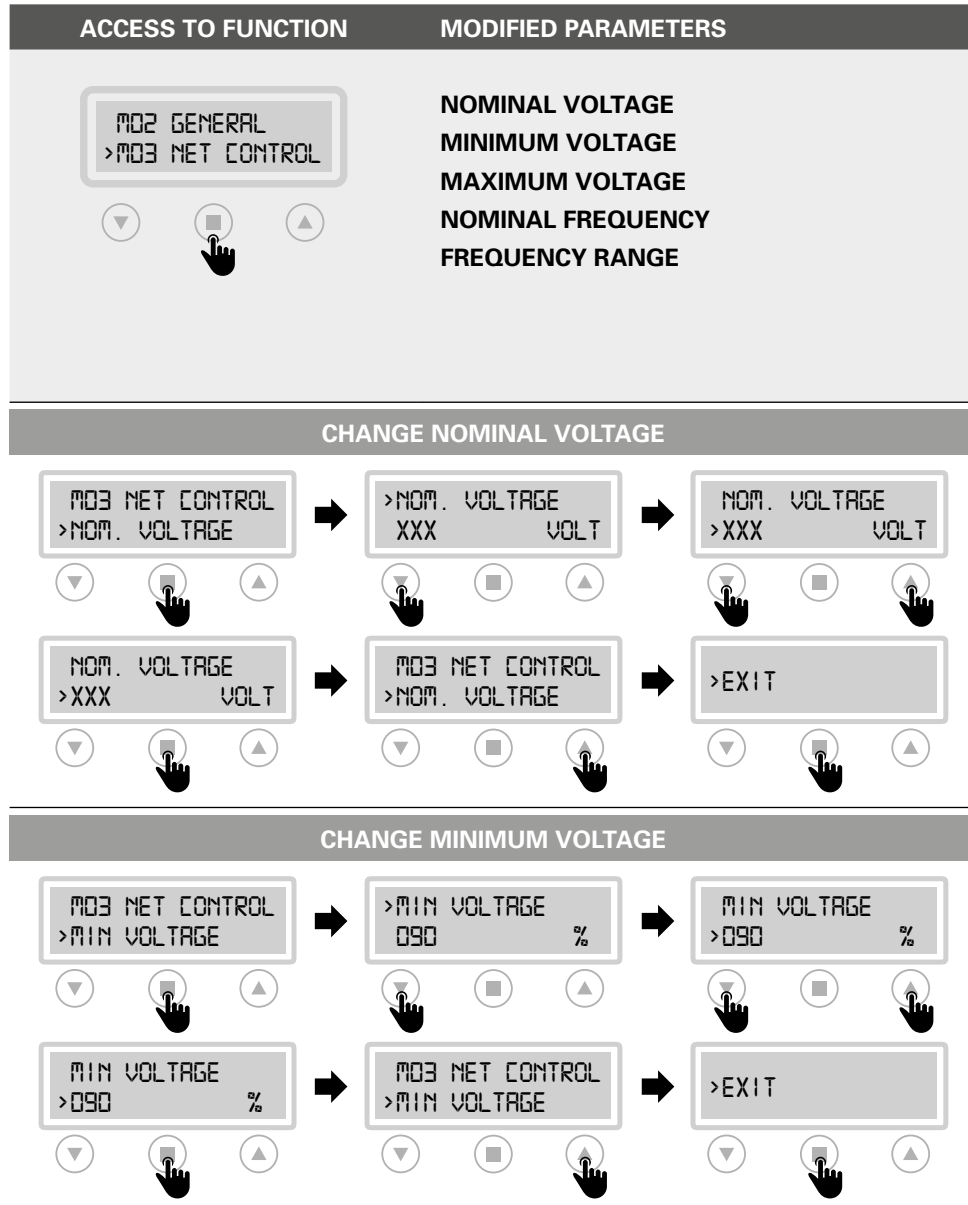

M04 PUMP 1

ACCESS TO FUNCTION	MODIFIED PARAMETERS
 <p>The amperage value shown on the display may differ $\pm 5\%$ from the nominal value of the pump (nameplate data) since the control panel is not a measuring instrument. The same value may differ depending on the operating conditions of the installation.</p>	<p>AUTOTUNING It allows the self-learning of the data to be carried out again</p> <p>NOMINAL CURRENT Set nominal/operating current of the pump</p> <p>MINIMUM AMPERAGE Current setting min. for dry running protection</p> <p>MAXIMUM AMPERAGE Max current setting for overcurrent protection</p> <p>START PER HOUR Set max number of pump starts per hour</p>

AUTOTUNING

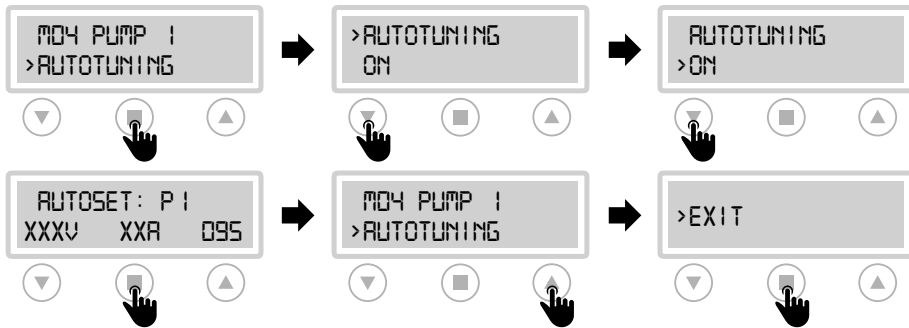

CHANGE NOMINAL CURRENT

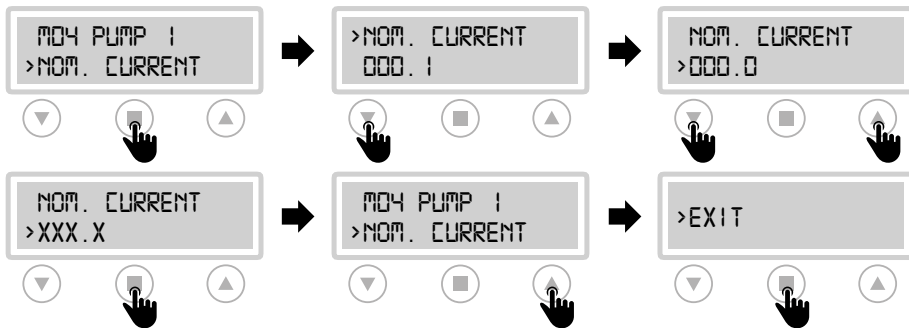

CHANGE MINIMUM AMPERAGE

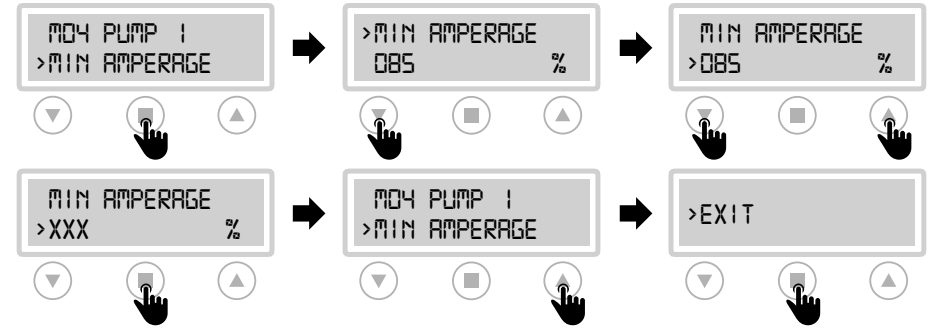

CHANGE MAXIMUM AMPERAGE

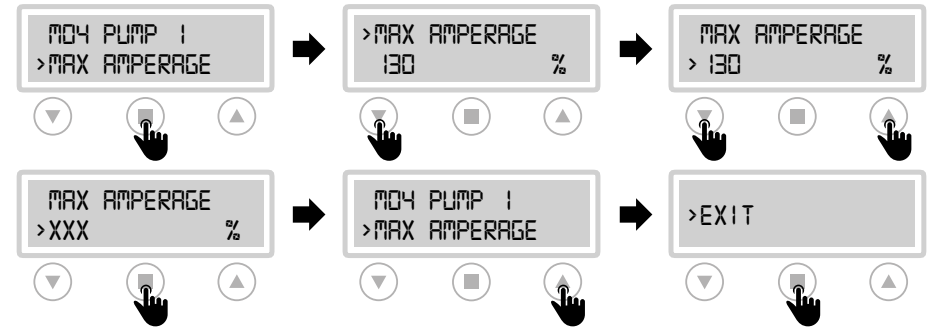



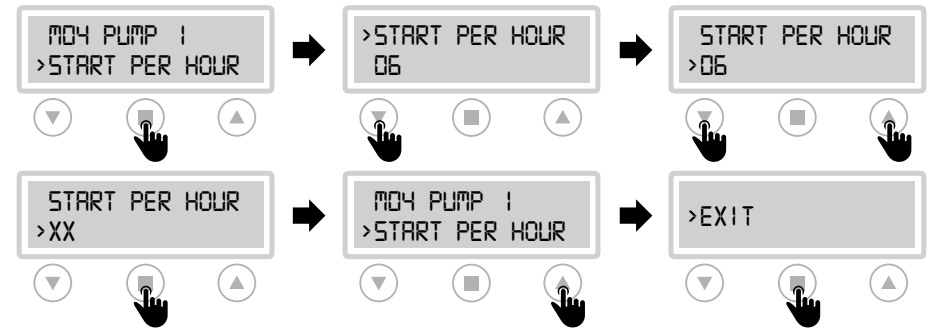



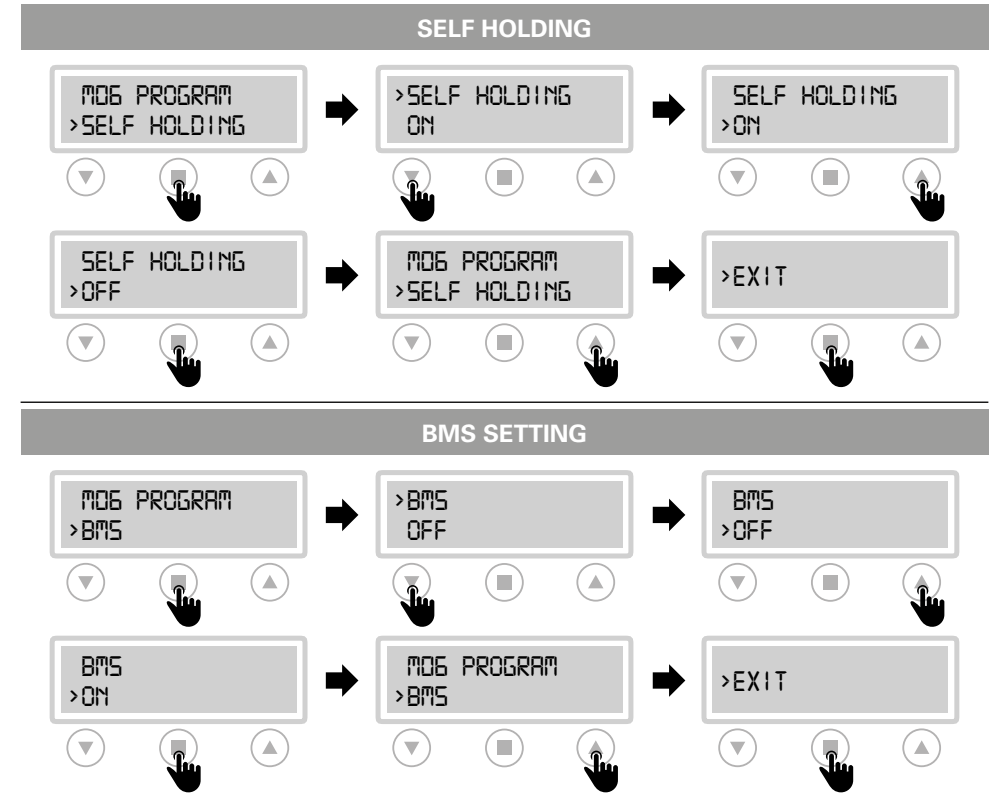
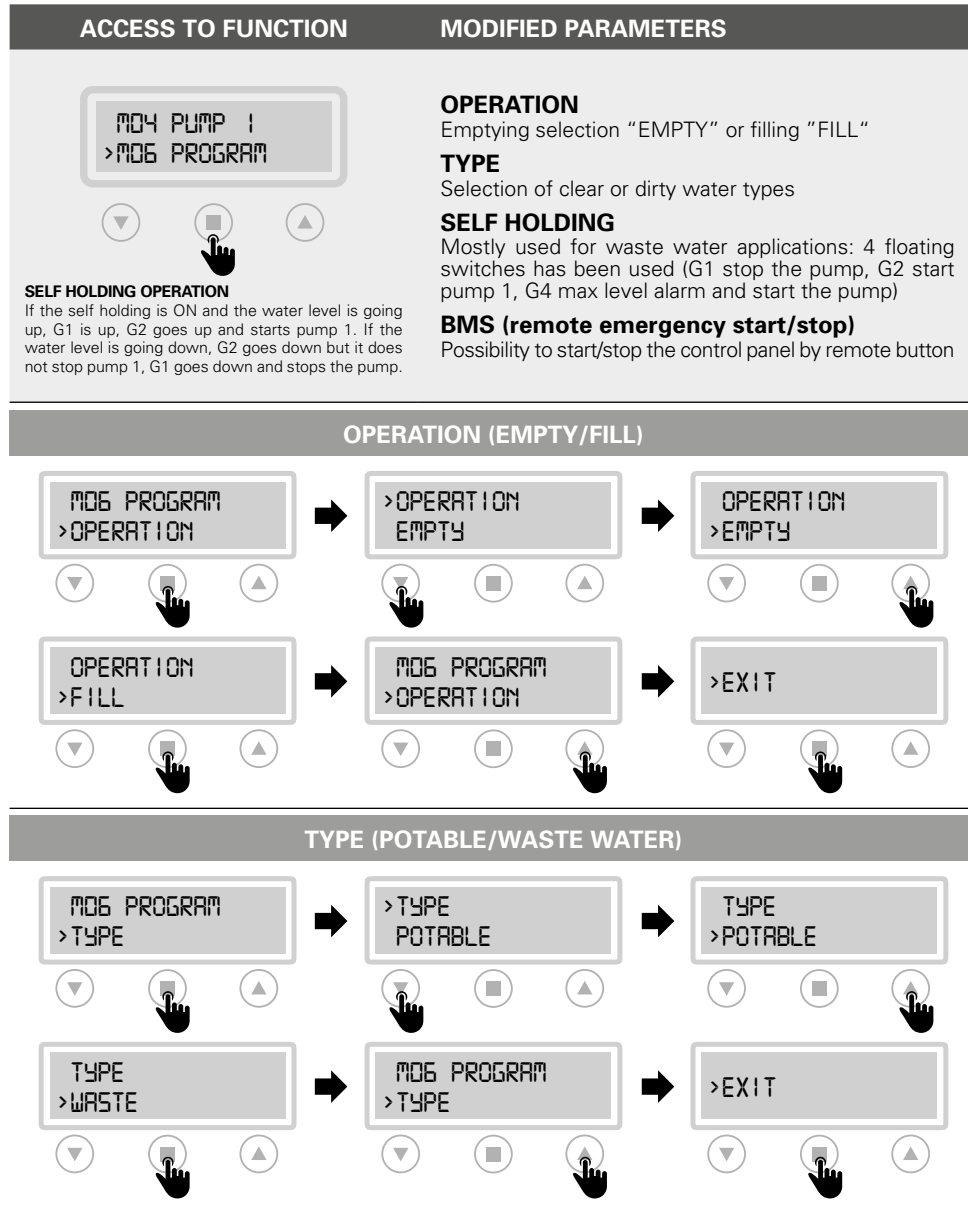



CHANGE START PER HOUR







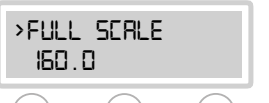
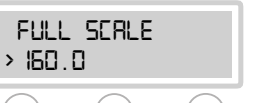
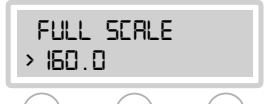





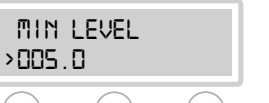

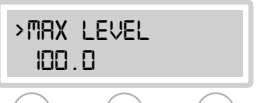
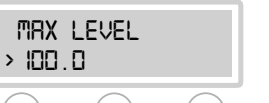

M06 PROGRAM

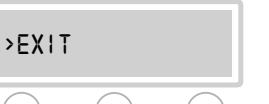

M07 SENSOR (sensor/trasducer 4÷20 mA)

ACCESS TO FUNCTION	MODIFIED PARAMETERS
 <p>The "SENSOR" function allows to use the control panel with piezoresistive, piezocapacitive level sensors or pressure transducers (logic 4÷20 mA).</p> <p>ATTENTION: Switch off the control panel before connecting the sensor.</p>	<p>PARAMETERS Setting unit of measure (mt/bar)</p> <p>FULL SCALE Set the full scale value specified by the manufacturer of the sensor used (serial value 160.0)</p> <p>MINIMUM LEVEL Parameter active only with unit of measure in mt</p> <p>MAXIMUM LEVEL Parameter active only with unit of measure in mt</p> <p>START P1 e STOP P1</p>
SET PARAMETERS	
  	  
SET FULL SCALE	
  	  

SET MINIMUM LEVEL		
  	  	
SET MAXIMUM LEVEL		
  	  	
PUMP 1 START		
  	  	

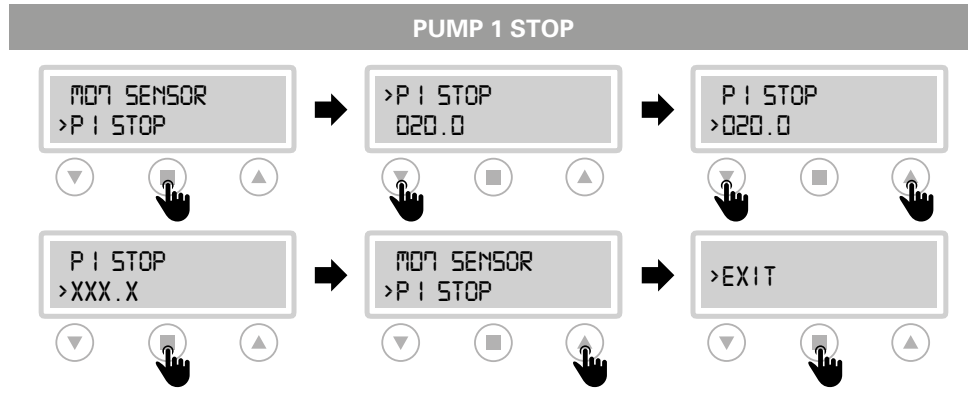

M08 TIMER

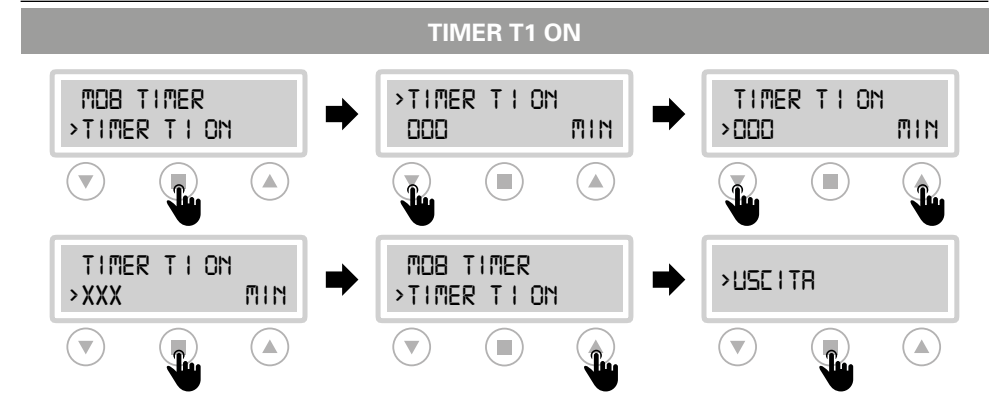
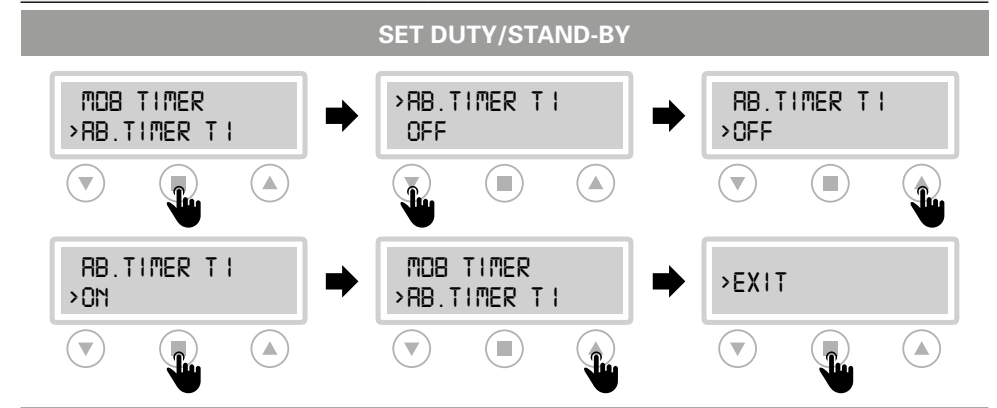
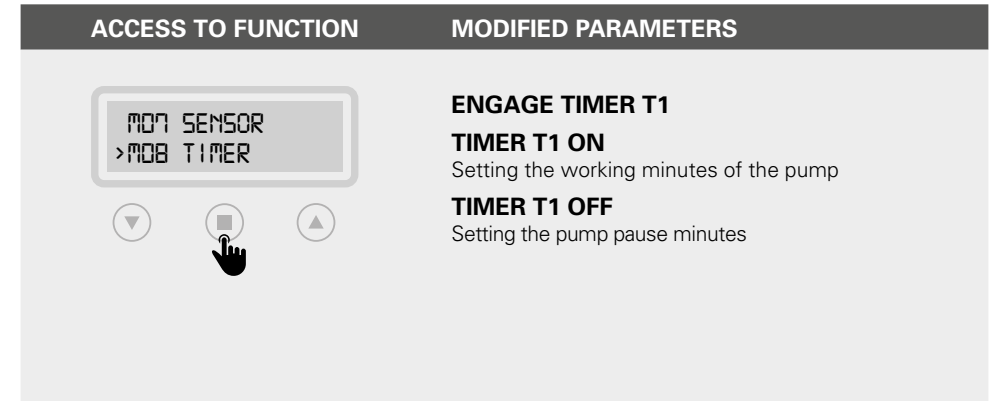

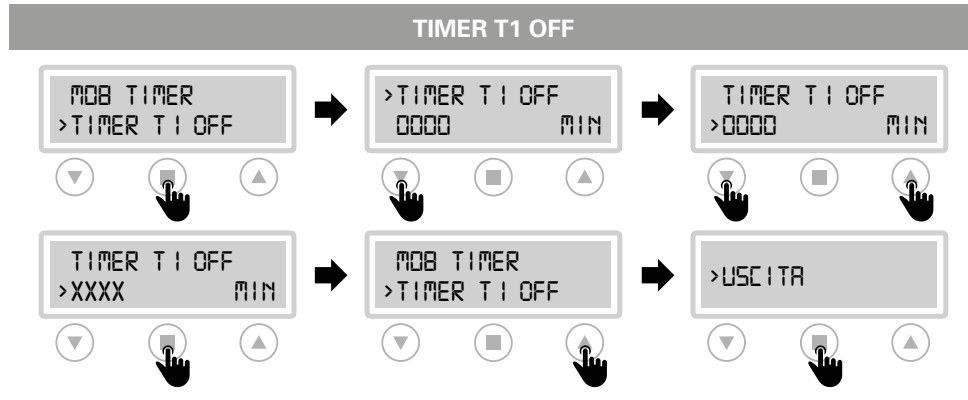

3.5 TRIMMER SETTINGS

To change manually the threshold protections, **interrupt the power supply to the control panel** and work on the trimmers, please following the below instructions:



PROTECTION DELAY
The pump protection switching delay has been set at **5 sec.**

TRIMMER SETTING	
	<p>TRIMMER 1: PROBE SENSITIVITY CHANGE</p> <p>Probe sensitivity (CLC) and water in oil chamber sensor trimmer regulation.</p> <p>It is possible to change the sensitivity of the CLC probes and the water sensor in the oil chamber, interrupting the power supply to the control panel and acting on trimmer 1 (clockwise to increase and counterclockwise to decrease sensitivity).</p>

3.6 ALARM CONTACT OUTPUTS

SINGLE PHASE VERSION	THREE PHASE VERSION
<p>Alarm outputs:</p> <ul style="list-style-type: none"> • L-OUT / N = 230 V c.a. • + -12 / NO = 12V c.c. or contact NO 	<p>Alarm outputs:</p> <ul style="list-style-type: none"> • L-OUT / N = 400 V c.a. • + -12 / NO = 12V c.c. or contact NO

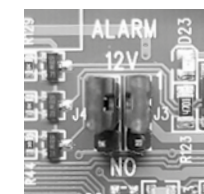
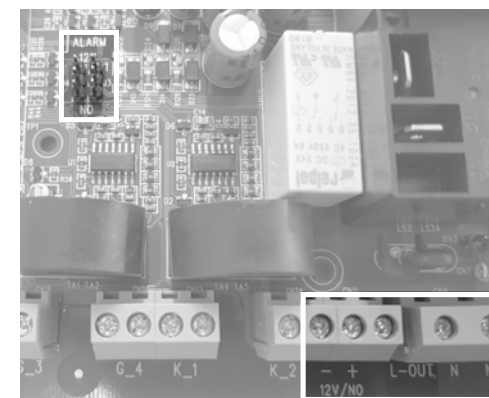



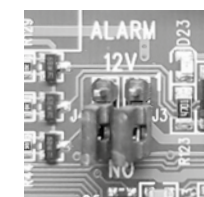



12 V c.c. output



free contact NO

4.1 KEYPAD AND LIGHTS INDICATIONS



CONTROL PANEL	
	PW blue light indicating power network presence and powered panel.
	ALARM red light to indicate a general alarm and pump stop. (min e max Amp, min e max V, min e max level, motor klixon, water in oil chamber, phase failure).
	START green light to indicate pump start; fixed on to indicate pump running, flashing to indicate auto-setting mode.
	AUT the button activates the auto-setting mode and automatic pump (if the green light is on, the automatic mode is active).
	0 pump stop button and reset alarms, sound alarm turn-off.
	MAN activation of manual pump; holding it down, the engine is operated in by-pass mode, bypassing all the protections.

4.2 ALARMS

The control panel signals a series of alarms that may occur during operation. Some of these stop the pumps, while others are only displayed.

All alarms are displayed on the panel (red LED flashing), while the display shows the code/alarms occurred until the cancellation by the operator.

ALARM CODE	ALARM DESCRIPTION	PUMP STOP	RELAY ON	LED SIGNAL
AL 1	MIN VOLTAGE	YES	YES	
AL 2	MAX VOLTAGE	YES	YES	
AL 3	LOW FREQUENCY	NO	YES	
AL 4	HIGH FREQUENCY	NO	YES	
AL 5	DRY RUNNING P1	YES	YES	
AL 6	MAX AMPERAGE P1	YES	YES	
AL 7	MAX STAR PER HOUR	NO	YES	
AL 8	WATER IN OIL CHAMBER P1	NO	YES	
AL 9	KLIXON P1	YES	YES	
AL 10	MIN LEVEL	YES	YES	
AL 11	MAX LEVEL	NO	YES	

ALARM WITH STOP PUMP



Following the detection of an alarm and the consequent blocking of the pump, the control panel provides the following operations:

- Try the first restart after 5 min.
- In case of a negative result, make another attempt after 30 min. and 3 other attempts with intervals of 60 min.
- After 5 attempts if the alarm persists, the control panel permanently blocks the pump and the alarm remains active until the user intervenes.

DELETE ALARM

P1



To delete the alarms, enter the "0" button.



IMPORTANT!

If after having canceled the alarm, the same occurs again, an intervention on the cause is necessary.

4.3 TYPICAL INSTALLATIONS

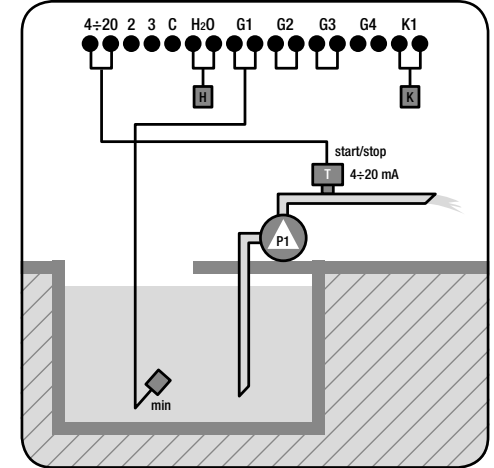
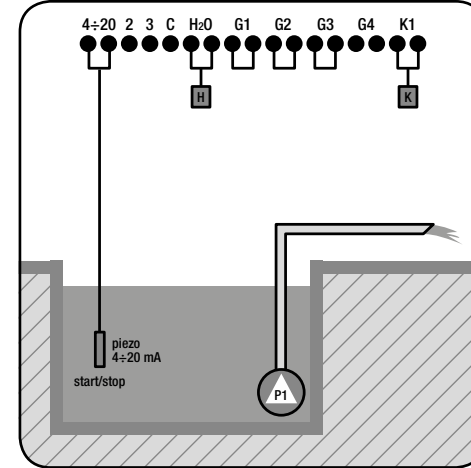
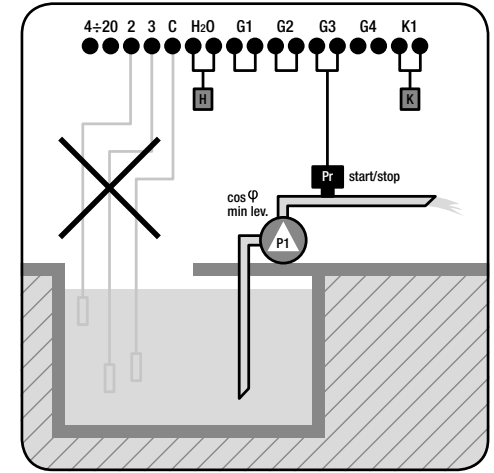
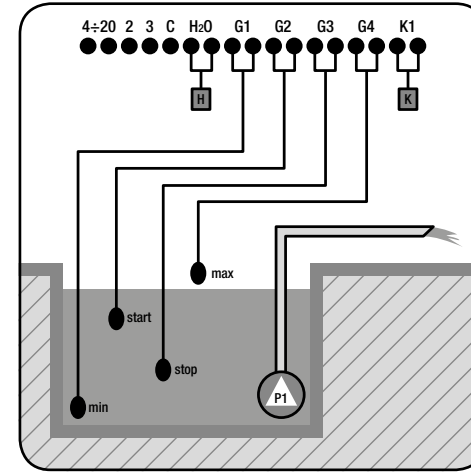
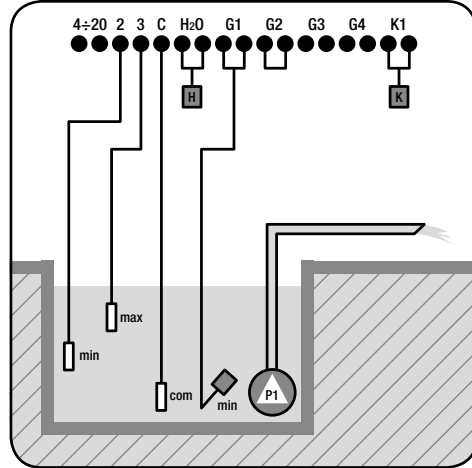
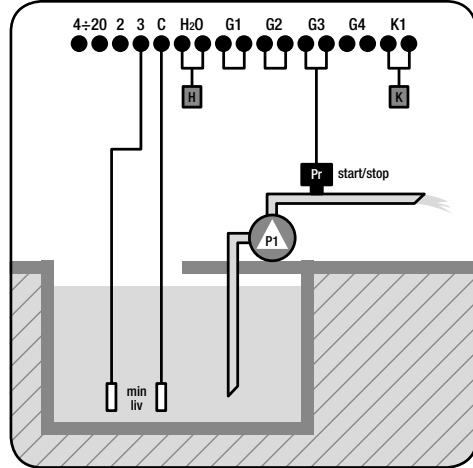
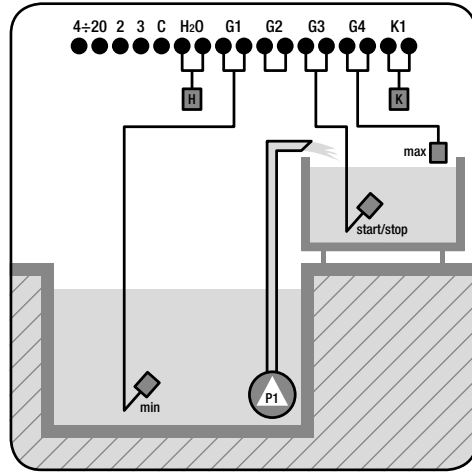
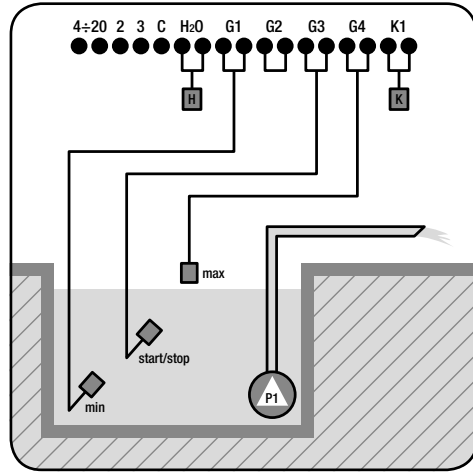



4÷20	input for 4÷20 mA sensor or pressure transducer
2/3/C	input for level probes
H	input for water in oil chamber sensor/water leakage
K	input for motor klixon
Pr	pressure switch
P	pump

T	pressure transducer
H	float switch for clear water
W	float switch for waste water
2	level probes
4÷20	4÷20 mA piezoresistive sensor

4÷20	input for 4÷20 mA sensor or pressure transducer
2/3/C	input for level probes
H	input for water in oil chamber sensor/water leakage
K	input for motor klixon
Pr	pressure switch
P	pump

T	pressure transducer
H	float switch for clear water
W	float switch for waste water
2	level probes
4÷20	4÷20 mA piezoresistive sensor

5.1 PUMPS STOP

MODE	BUTTON	STOP
MANUAL		The motor stops when the "MANUAL" button is released or once you digit the 0 button.
AUTOMATIC		When the input commands are disable/non active once you digit the 0 button.
OFF		Turning the main switch interlocking door in "OFF" position.

5.2 SERVICE

EPIC 1D does not require any routine maintenance provided that their working limits are observed. Any maintenance operations must be performed by qualified and experienced personnel, in compliance with the safety regulations in force.



DANGER!
Make sure that EPIC 1D is disconnected from the power supply before performing any maintenance operations.

5.3 SPARE PARTS

Always state the exact model identification number and construction number when requesting technical information or spare parts from our sales and service centre.

Use only original spare parts when replacing any faulty components. The use of unsuitable spare parts can cause malfunctions, personal injury and damage to property.

5.4 WASTE DISPOSAL

After the control panel has been installed and started, the customer must provide for the appropriate elimination/disposal of the waste materials according to the legislation locally in force. If the control panel or parts of it must be taken out of service and dismantled, follow local regulations regarding sorted waste disposal. Refer to the appropriate recycling centres.



CAUTION!
Contamination of the environment with hazardous substances such as battery acid, fuel, oil, plastic, copper, etc., may cause serious damage to the environment and endanger people's health.

6.1 CERTIFICATE OF CONFORMITY

DECLARES UNDER HIS OWN RESPONSIBILITY THAT THE FOLLOWING CONTROL PANELS:

EPIC 1D -230 e EPIC 1D -400

ARE IN CONFORMITY WITH COMMUNITY DIRECTIVES REGARDING:

- European directive 2006/95/CE
- Electromagnetic compatibility directive 2004/108/CE



AND AS APPLICABLE TO HARMONIZED STANDARDS:

- EN 61439-1
- EN 61439-2
- EN 60204-1
- EN 55014-1
- EN 55014-2
- EN 61000-3-2
- EN 61000-3-3

Moreover Mr. Giuseppe Franchin, as the legal representative of the company, is the person authorized to compile the technical documentation file.

Polverara - Italy, 10/01/2018



Technical Manager
(Giuseppe Franchin)



Automated Environmental Systems

Tel: **01842 819130**

Email: sales@automatedenvironmentalsystems.co.uk

www.automatedenvironmentalsystems.co.uk

